

---

# MOONBOX IO

---

Product card

---

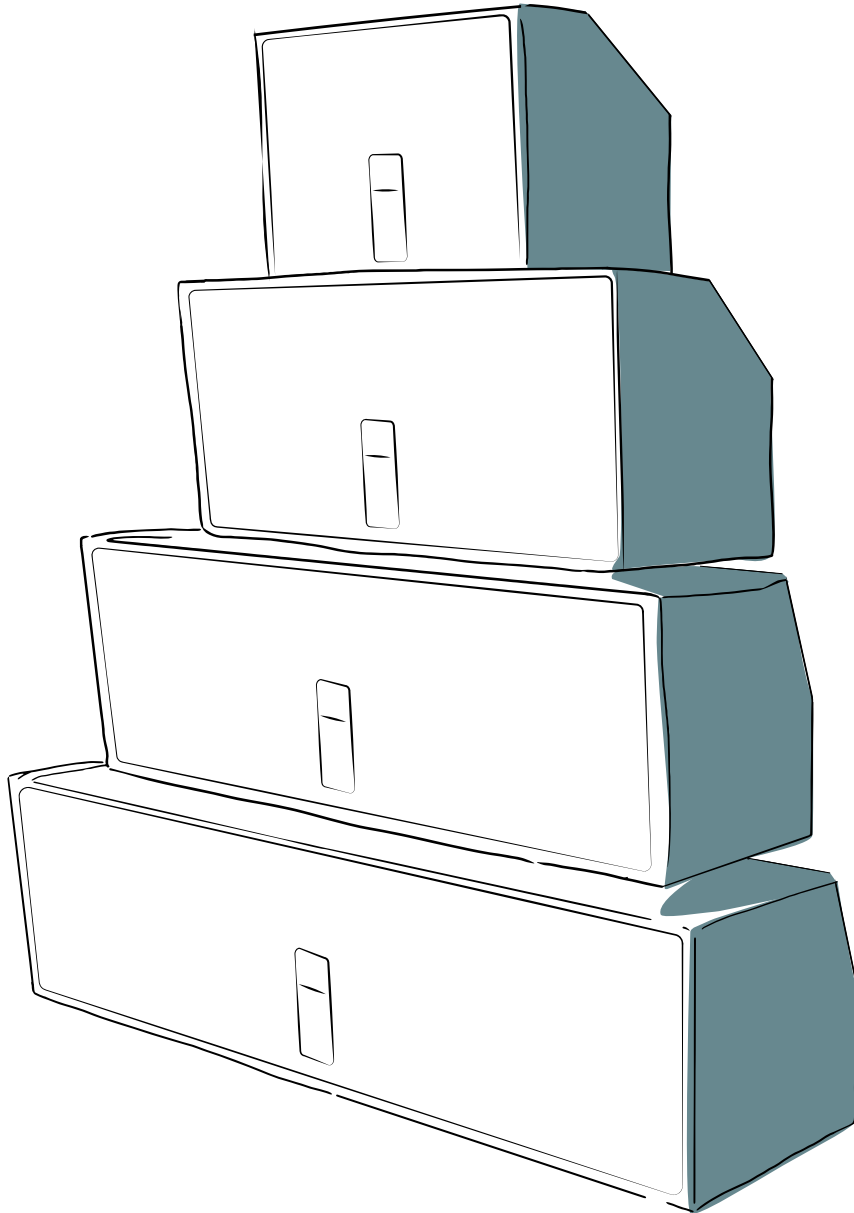

Live light at  
**vandermoon.com**





Since 1993, Vitberg has been producing medical devices for rehabilitation, treatment, cosmetology and sports.

Its products are known and appreciated.

Medicine and technology are not our only passion, we also love exploring the world.

We have translated the experience gained over the years into the production of accessories for people like us.

This is how the Van Der Moon brand was born.

Made in Poland, EU.

[www.vandermoon.com](http://www.vandermoon.com)

---

# General information

---

## MOON BOX IO – Technical Specification

Moon Box IO represents a new generation of rigid wall-mounted aluminum cabinets specifically designed for campervans and boats. The construction is made entirely of high-quality aluminum, with every element precision-cut and bent in our factory. We assemble all connections using aircraft-grade rivets and additional reinforcement to ensure maximum durability and vibration resistance. The entire structure receives a specialized powder coating through electrostatic spraying, resulting in a perfectly smooth surface with exceptional scratch resistance.

Moon Box IO comes in four sizes (25, 40, 50, or 65 cm) while maintaining a compact height of 26.7 cm for optimal space utilization. The front doors feature lightweight plywood with natural oak veneer, protected by three layers of yacht varnish for lasting durability. Each cabinet comes equipped with professional lever locks that combine durability, reliability, and protection against accidental opening during travel. The hydraulic piston hinges ensure smooth, silent operation while providing easy access to stored items.

The innovative MOLLE system, available as an option, represents our unique approach to storage customization. Instead of traditional webbing straps, we CNC laser-cut it from aluminum, creating a robust platform for attaching various accessories. Customers can choose to enhance their MOLLE system with integrated LED lighting, featuring both white and red modes for versatile illumination options. The cabinet includes three strategically placed ventilation points that allow for complete air exchange within 45 minutes.

All production stages are carried out in our Polish factory, from initial cutting and bending to final polishing and painting, ensuring precise quality control of each element. We stand behind our product with a 10-year warranty, confirming our confidence in Moon Box IO's durability and performance in any environment.

### Compatible car models:

#### Angle 109°

Mercedes Sprinter  
Volkswagen Crafter I  
Volkswagen LT  
Ford Transit MK8  
Nissan NV400  
Renault Master 3  
Opel Movano 2

#### Angle 105°

Ford Transit MK7

#### Angle 101,5°

MAN TGE  
Volkswagen Crafter II  
RAM Promaster  
Fiat Ducato III  
Citroen Jumer II  
Peugeot Boxer II  
Opel Movano 3  
Toyota Proace Max

#### Angle 90°

Fits: RVs, Boats & Vans (90° wall-ceiling angle)

---

# MoonBox IO

---



## MoonBox IO 25

**Size:** 250x267x259 mm  
**Weight:** 1,7 kg (+/-100g)  
**Capacity:** 17 l

Available colours:



## MoonBox IO 40

**Size:** 400x267x259 mm  
**Weight:** 2,5 kg (+/-100g)  
**Capacity:** 27 l

Available colours:



## MoonBox IO 50

**Size:** 500x267x259 mm  
**Weight:** 3 kg (+/-100g)  
**Capacity:** 34 l

Available colours:



## MoonBox IO 65

**Size:** 650x267x259 mm  
**Weight:** 3,5 kg (+/-100g)  
**Capacity:** 44 l

Available colours:



---

# MoonBox IO Wood

---



## MoonBox IO Wood 25

**Size:** 268x267x259 mm  
**Weight:** 2,4 kg (+/-100g)  
**Capacity:** 17 l

Available colours:



## MoonBox IO Wood 40

**Size:** 418x267x259 mm  
**Weight:** 3,2 kg (+/-100g)  
**Capacity:** 27 l

Available colours:



## MoonBox IO Wood 50

**Size:** 518x267x259 mm  
**Weight:** 3,7 kg (+/-100g)  
**Capacity:** 34 l

Available colours:



## MoonBox IO Wood 65

**Size:** 668x267x259 mm  
**Weight:** 4,2 kg (+/-100g)  
**Capacity:** 44 l

Available colours:



---

# MoonBox IO Molle + Light

---



## MoonBox IO Molle + Light 25

**Size:** 250x267x259 mm

**Weight:** 1,8 kg (+/-100g)

**Capacity:** 15 l

Available colours:



## MoonBox IO Molle + Light 40

**Size:** 400x267x259 mm

**Weight:** 2,7 kg (+/-100g)

**Capacity:** 24 l

Available colours:



## MoonBox IO Molle + Light 50

**Size:** 500x267x259 mm

**Weight:** 3,2 kg (+/-100g)

**Capacity:** 30 l

Available colours:



## MoonBox IO Molle + Light 65

**Size:** 650x267x259 mm

**Weight:** 3,8 kg (+/-100g)

**Capacity:** 40 l

Available colours:



---

# MoonBox IO Wood + Molle + Light

---



## MoonBox IO Wood Molle + Light **25**

**Size:** 268x267x259 mm

**Weight:** 2,5 kg (+/-100g)

**Capacity:** 15 l

Available colours:



## MoonBox IO Wood Molle + Light **40**

**Size:** 418x267x259 mm

**Weight:** 3,4 kg (+/-100g)

**Capacity:** 24 l

Available colours:



## MoonBox IO Wood Molle + Light **50**

**Size:** 518x267x259 mm

**Weight:** 3,9 kg (+/-100g)

**Capacity:** 30 l

Available colours:



## MoonBox IO Wood Molle + Light **65**

**Size:** 668x267x259 mm

**Weight:** 4,5 kg (+/-100g)

**Capacity:** 40 l

Available colours:



---

# MoonBox IO Kitchen

---



## MoonBox IO Kitchen 65

**Size:** 650x267x259 mm  
**Weight:** 3,8 kg (+/-100g)  
**Capacity:** 40 l

Available colours:



## MoonBox IO Kitchen Wood 65

**Size:** 668x267x259 mm  
**Weight:** 4,5 kg (+/-100g)  
**Capacity:** 40 l

Available colours:



---

# MoonBox IO Special

---

IO Special is a fully configurable version of our standard aluminum cabinet, offering precise width adjustment in 1 cm increments within the range of 25 to 65 cm. The modular construction with removable side walls allows multiple units to be combined into one long cabinet with multiple access doors while maintaining full structural integrity. The distinguishing feature of IO Special is the possibility of individual side wall profiling, which is precisely cut to perfectly align with the vehicle's upholstery contours.

IO Special is manufactured without the MOLLE system as standard due to its custom nature. The MOLLE system is available as an optional feature - details can be arranged via email when placing an order. The construction is made of the same high-quality aluminum with natural oak veneer front finishing. All elements are manufactured to order in our factory using CNC technology, ensuring the highest precision and perfect fit for your vehicle space.



# MoonBox IO 25 angle 90°

Maximum self load

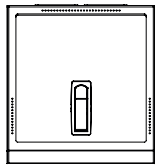

**MOON BOX IO 25**

Maximum self load

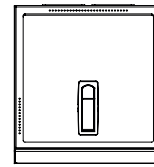

**MOON BOX IO MOLLE 25**

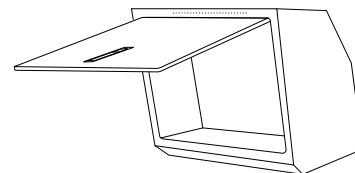
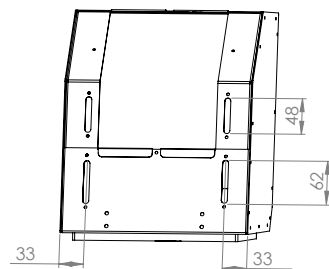
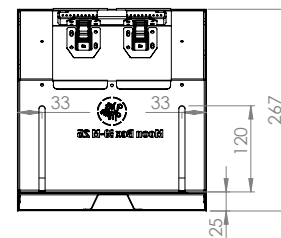
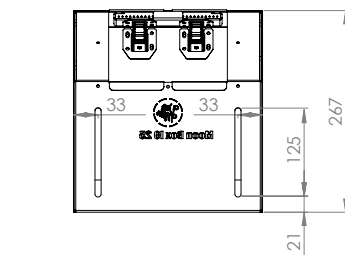
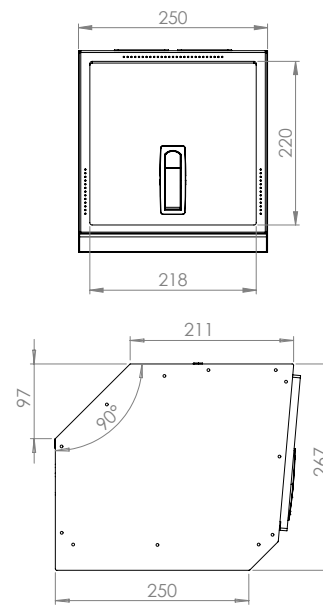
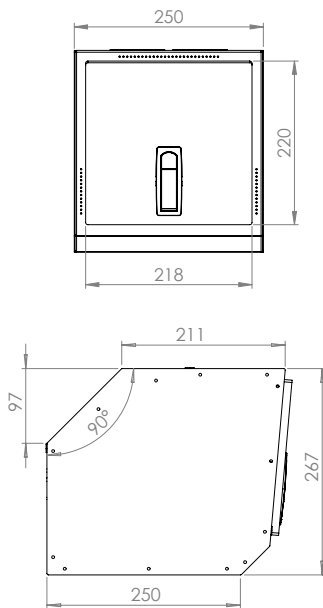

## Compatible car models:

Fits: RVs, Boats & Vans (90° wall-ceiling angle)

## Note:

Moon Box Wood versions: total width increases by 20mm compared to standard models. Side panels use identical construction as front panels - plywood with natural oak veneer finish.

# MoonBox IO 25

# angle 101,5°

Maximum self load

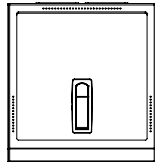

**MOON BOX IO 25**

Maximum self load

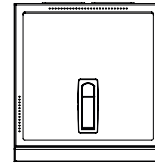

**MOON BOX IO MOLLE 25**

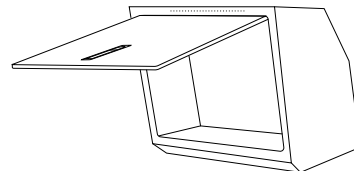
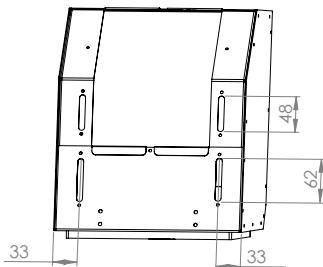
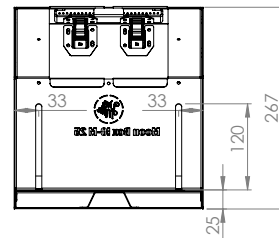
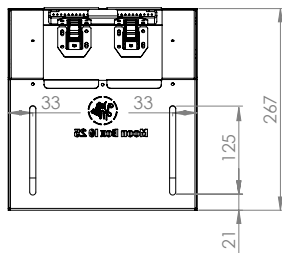
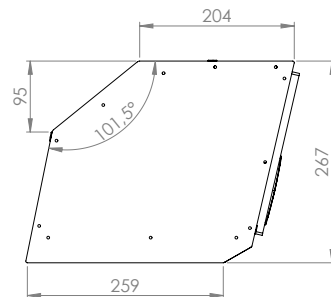
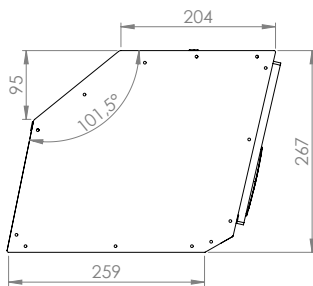
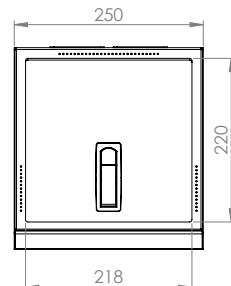
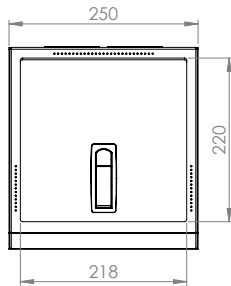

## Compatible car models:

- |                       |                   |
|-----------------------|-------------------|
| MAN TGE               | Citroen Jumer II  |
| Volkswagen Crafter II | Peugeot Boxer II  |
| RAM Promaster         | Opel Movano 3     |
| Fiat Ducato III       | Toyota Proace Max |

## Note:

Moon Box Wood versions: total width increases by 20mm compared to standard models. Side panels use identical construction as front panels - plywood with natural oak veneer finish.

# MoonBox IO 25 angle 105°

Maximum self load

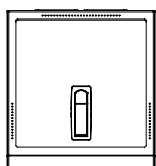

**MOON BOX IO 25**

Maximum self load

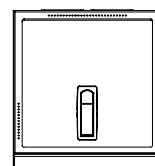

**MOON BOX IO MOLLE 25**

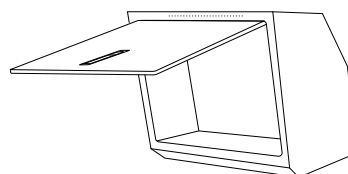
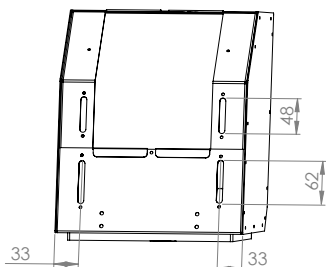
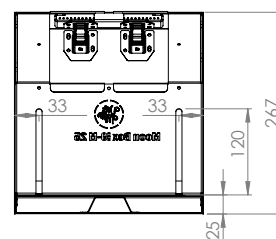
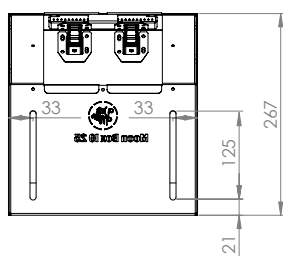
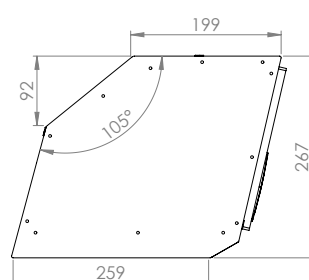
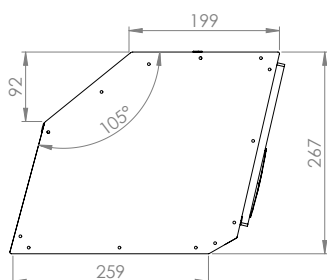
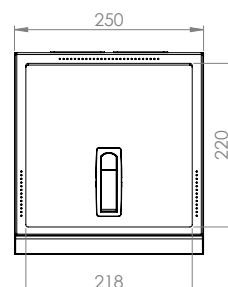
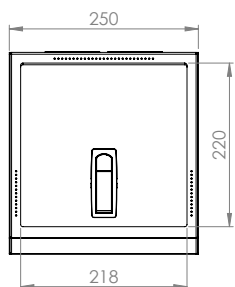

**Compatible car models:**

Ford Transit MK7

**Note:**

Moon Box Wood versions: total width increases by 20mm compared to standard models. Side panels use identical construction as front panels - plywood with natural oak veneer finish.

# MoonBox IO 25      angle 109°

Maximum self load

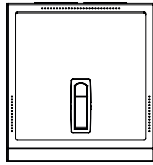

**MOON BOX IO 25**

Maximum self load

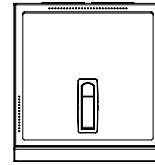

**MOON BOX IO MOLLE 25**

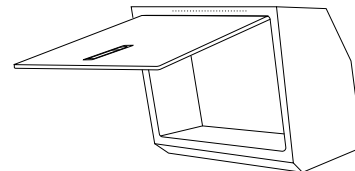
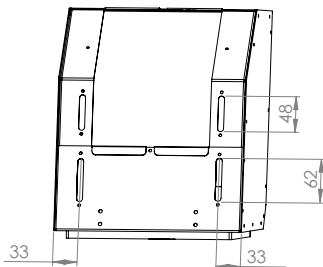
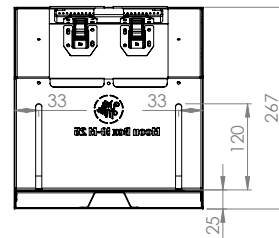
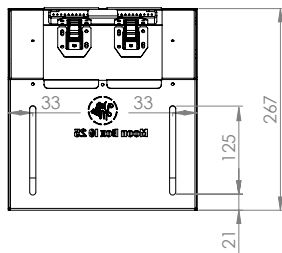
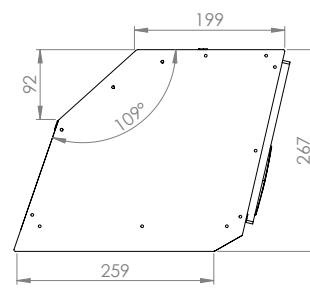
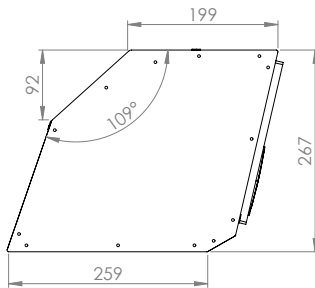
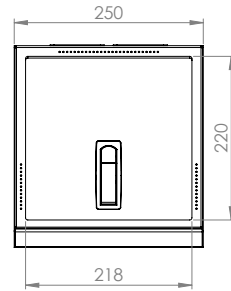
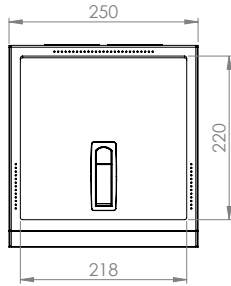

## Compatible car models:

- |                      |                  |
|----------------------|------------------|
| Mercedes Sprinter    | Nissan NV400     |
| Volkswagen Crafter I | Renault Master 3 |
| Volkswagen LT        | Opel Movano 2    |
| Ford Transit MK8     |                  |

## Note:

Moon Box Wood versions: total width increases by 20mm compared to standard models. Side panels use identical construction as front panels - plywood with natural oak veneer finish.

# MoonBox IO 40 angle 90°

Maximum self load

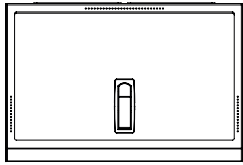

**MOON BOX IO 40**

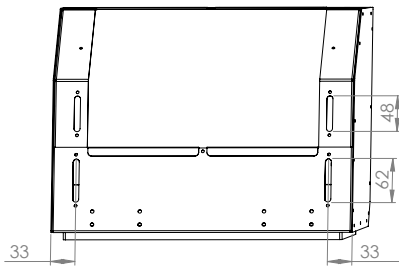
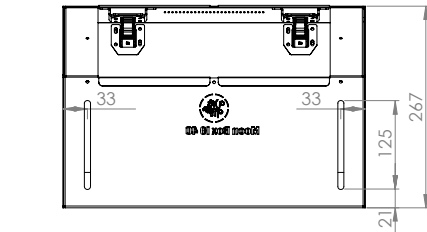
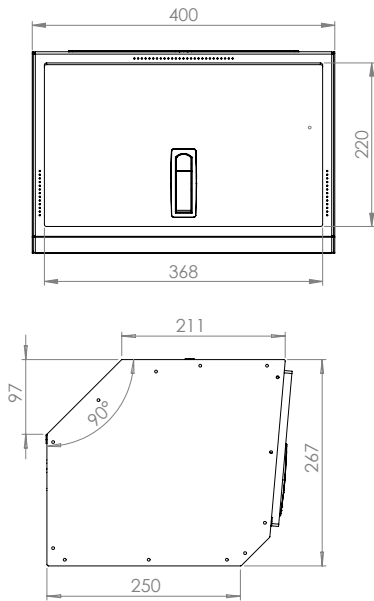

Maximum self load

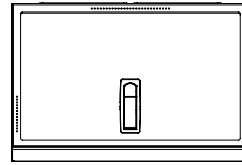

**MOON BOX IO MOLLE 40**

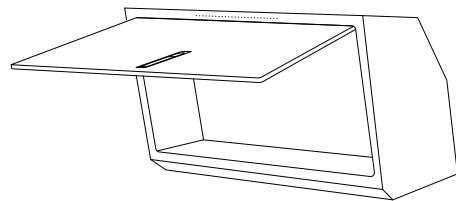
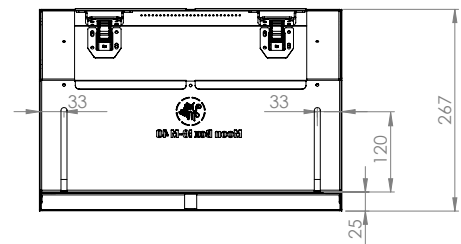
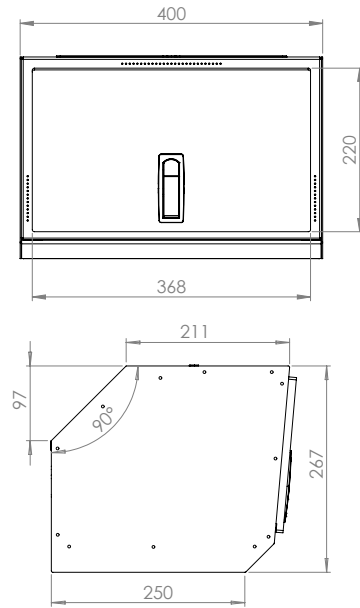

**Compatible car models:**

Fits: RVs, Boats & Vans (90° wall-ceiling angle)

**Note:**

Moon Box Wood versions: total width increases by 20mm compared to standard models. Side panels use identical construction as front panels - plywood with natural oak veneer finish.

# MoonBox IO 40 angle 101,5°

Maximum self load

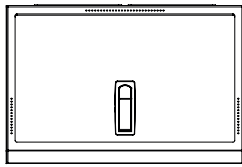

**MOON BOX IO 40**

Maximum self load

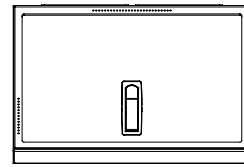

**MOON BOX IO MOLLE 40**

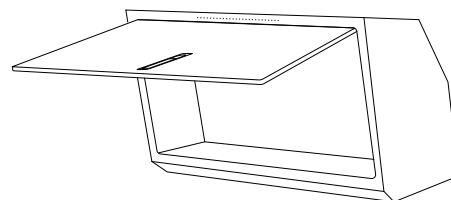
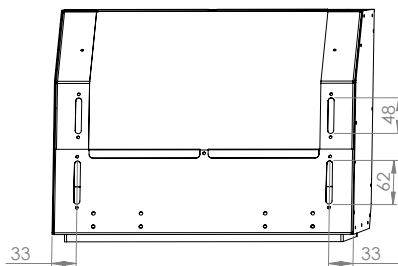
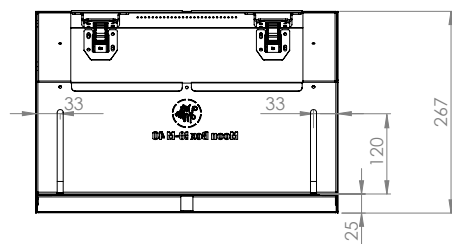
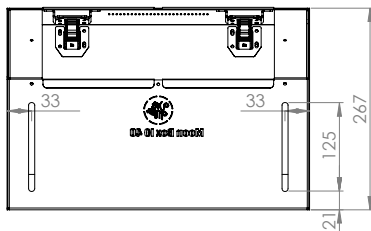
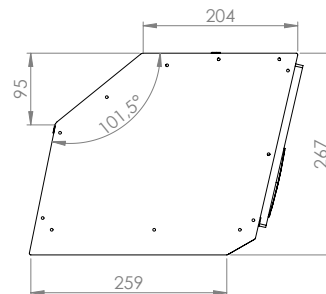
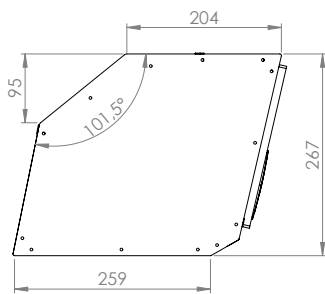
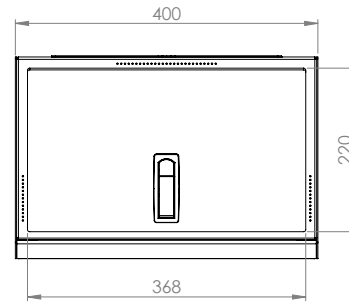
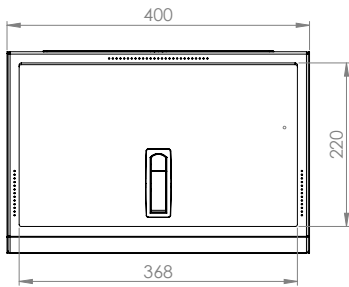

**Compatible car models:**

- |                       |                   |
|-----------------------|-------------------|
| MAN TGE               | Citroen Jumer II  |
| Volkswagen Crafter II | Peugeot Boxer II  |
| RAM Promaster         | Opel Movano 3     |
| Fiat Ducato III       | Toyota Proace Max |

**Note:**

Moon Box Wood versions: total width increases by 20mm compared to standard models. Side panels use identical construction as front panels - plywood with natural oak veneer finish.

# MoonBox IO 40 angle 105°

Maximum self load

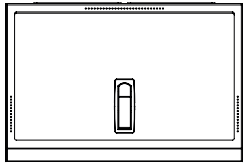

**MOON BOX IO 40**

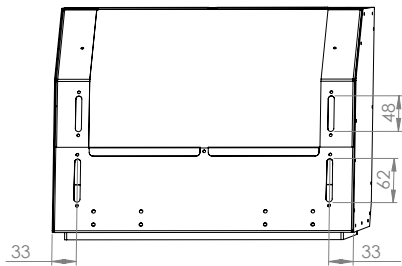
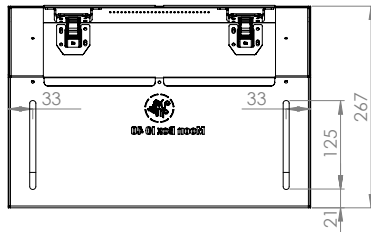
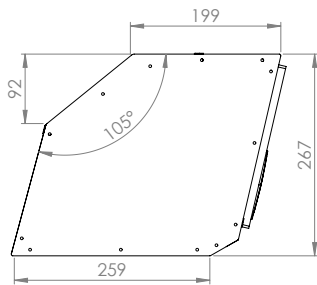
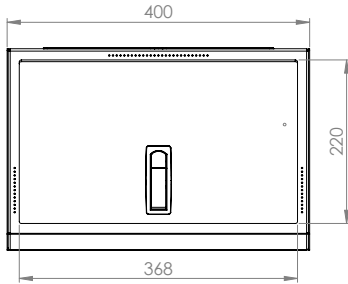

Maximum self load

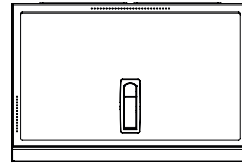

**MOON BOX IO MOLLE 40**

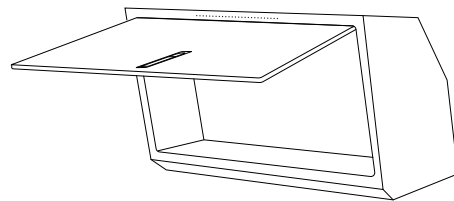
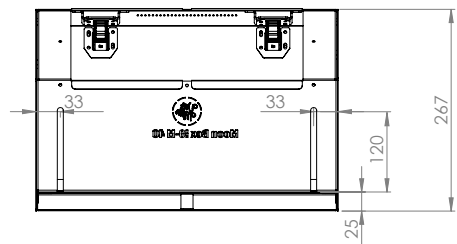
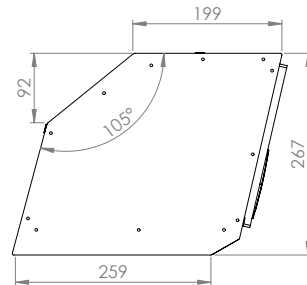
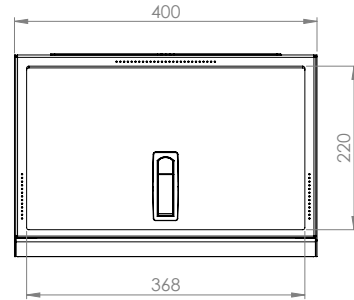

## Compatible car models:

Ford Transit MK7

## Note:

Moon Box Wood versions: total width increases by 20mm compared to standard models. Side panels use identical construction as front panels - plywood with natural oak veneer finish.

# MoonBox IO 40 angle 109°

Maximum self load

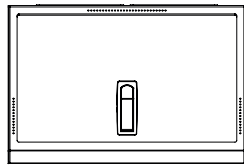

**MOON BOX IO 40**

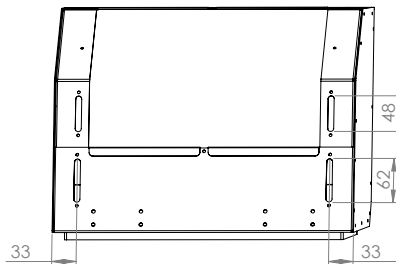
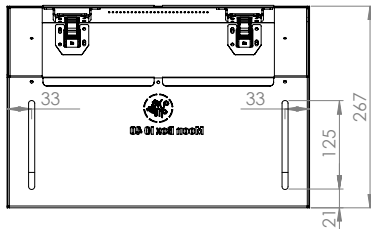
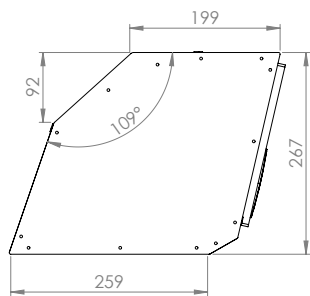
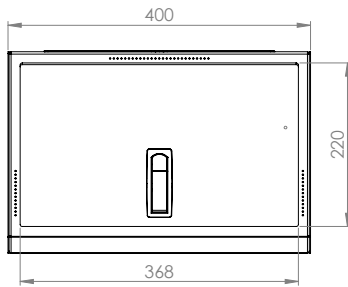

Maximum self load

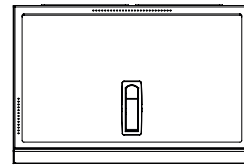

**MOON BOX IO MOLLE 40**

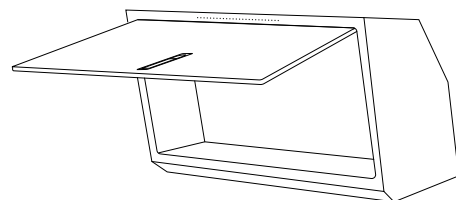
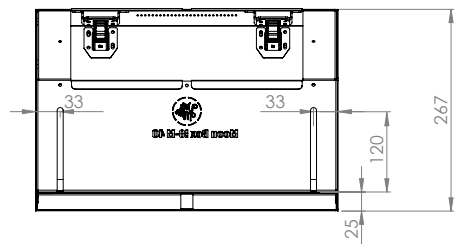
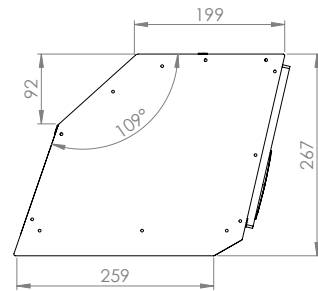
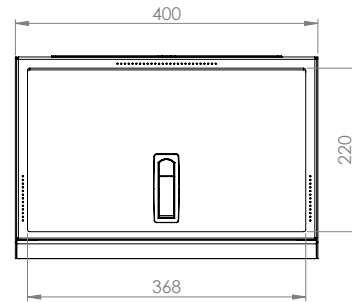

## Compatible car models:

- |                      |                  |
|----------------------|------------------|
| Mercedes Sprinter    | Nissan NV400     |
| Volkswagen Crafter I | Renault Master 3 |
| Volkswagen LT        | Opel Movano 2    |
| Ford Transit MK8     |                  |

## Note:

Moon Box Wood versions: total width increases by 20mm compared to standard models. Side panels use identical construction as front panels - plywood with natural oak veneer finish.



# MoonBox IO 50 angle 90°

Maximum self load

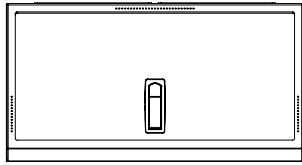

**MOON BOX IO 50**

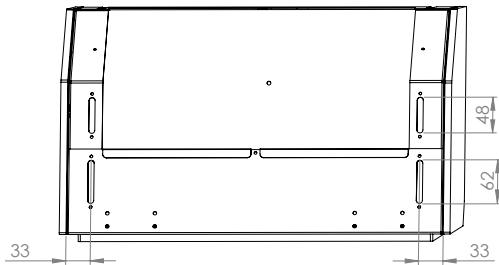
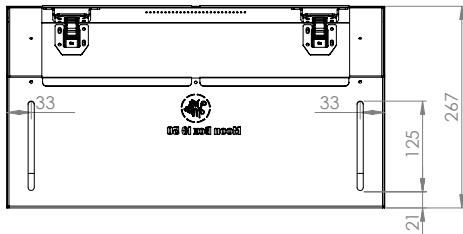
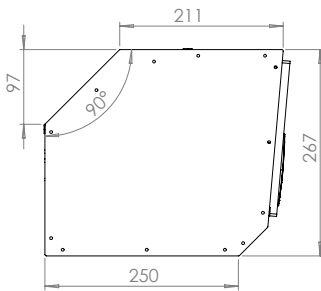
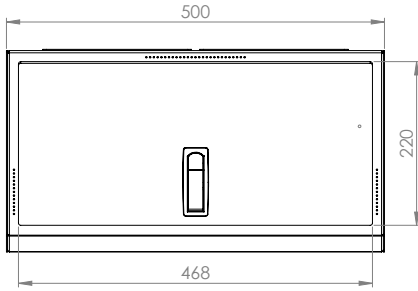

Maximum self load

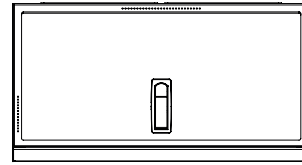

**MOON BOX IO MOLLE 50**

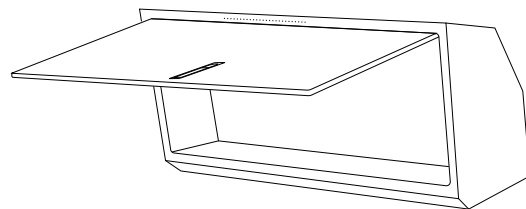
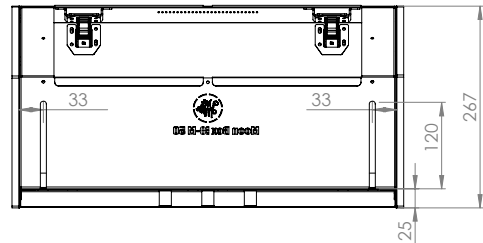
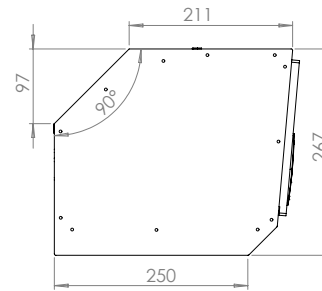
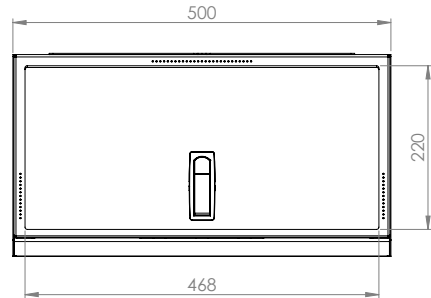

## Compatible car models:

Fits: RVs, Boats & Vans (90° wall-ceiling angle)

## Note:

Moon Box Wood versions: total width increases by 20mm compared to standard models. Side panels use identical construction as front panels - plywood with natural oak veneer finish.

# MoonBox IO 50

# angle 101,5°

Maximum self load

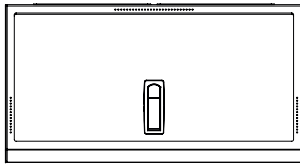

**MOON BOX IO 50**

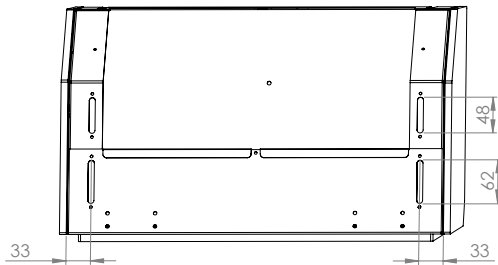
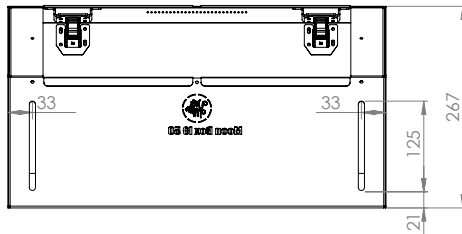
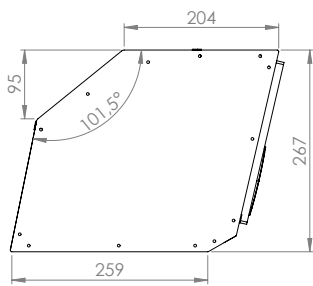
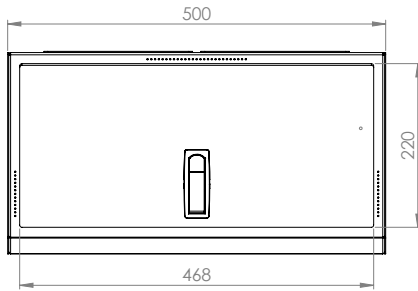

Maximum self load

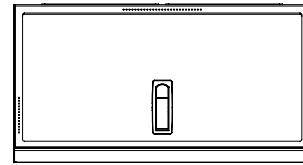

**MOON BOX IO MOLLE 50**

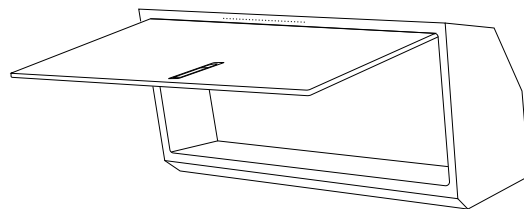
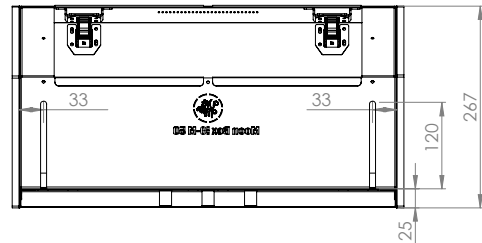
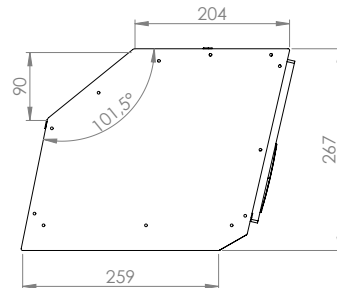
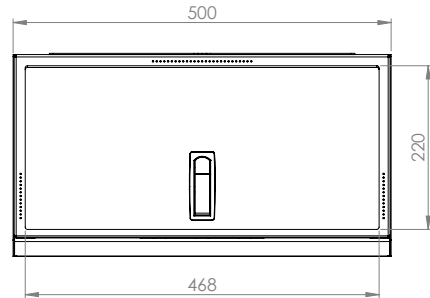

## Compatible car models:

MAN TGE

Volkswagen Crafter II

RAM Promaster

Fiat Ducato III

Citroen Jumer II

Peugeot Boxer II

Opel Movano 3

Toyota Proace Max

## Note:

Moon Box Wood versions: total width increases by 20mm compared to standard models. Side panels use identical construction as front panels - plywood with natural oak veneer finish.

# MoonBox IO 50 angle 105°

Maximum self load

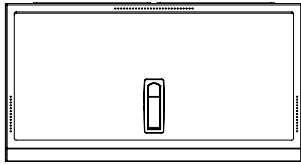

**MOON BOX IO 50**

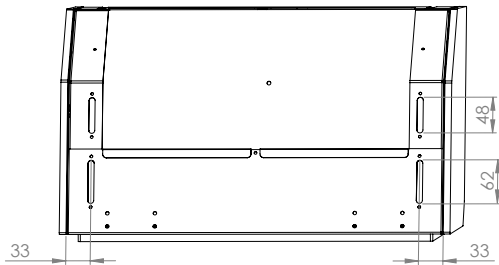
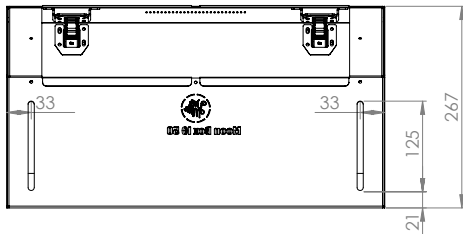
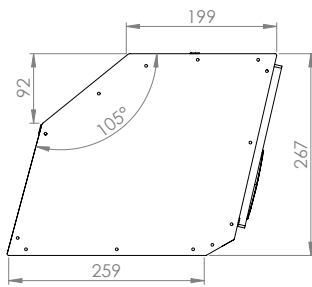
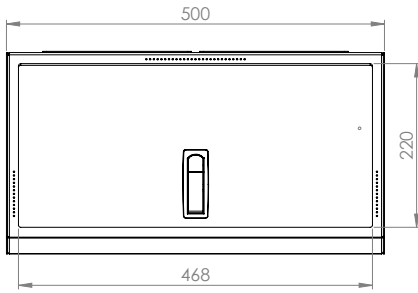

Maximum self load

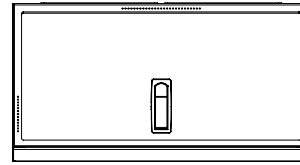

**MOON BOX IO MOLLE 50**

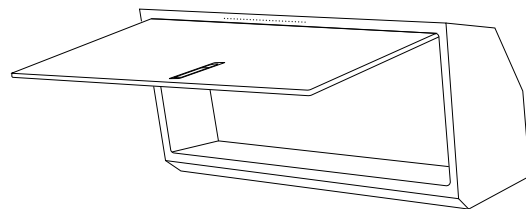
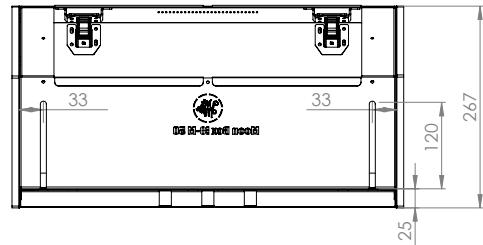
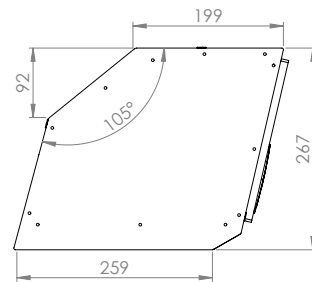
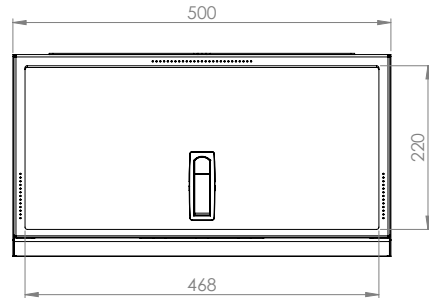

**Compatible car models:**

Ford Transit MK7

**Note:**

Moon Box Wood versions: total width increases by 20mm compared to standard models. Side panels use identical construction as front panels - plywood with natural oak veneer finish.

# MoonBox IO 50 angle 109°

Maximum self load

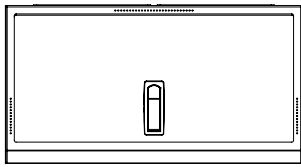

**MOON BOX IO 50**

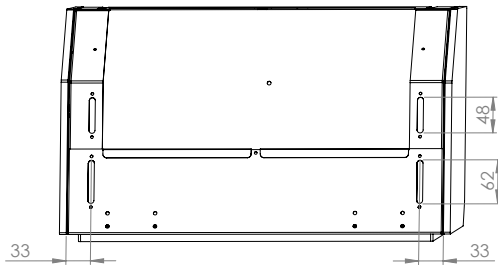
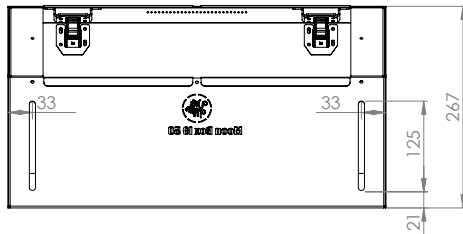
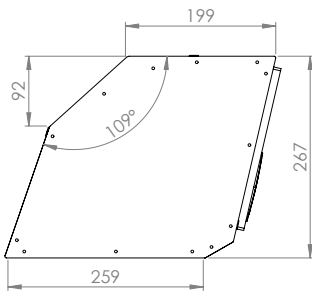
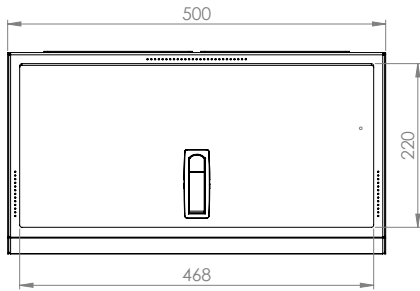

Maximum self load

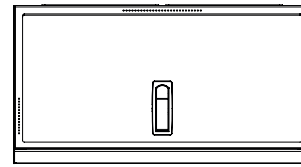

**MOON BOX IO MOLLE 50**

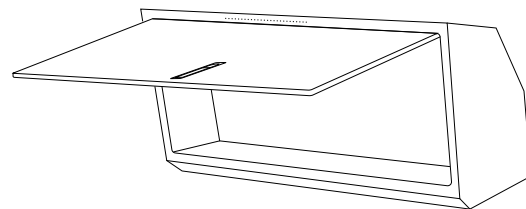
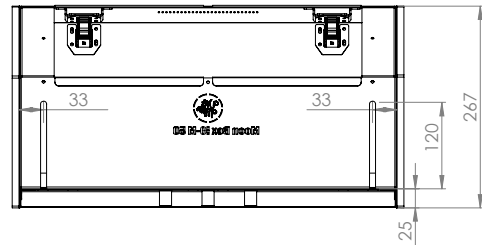
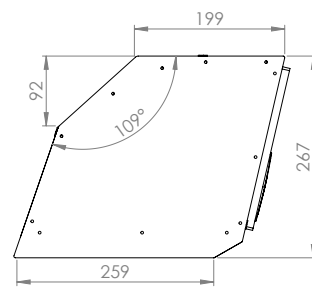
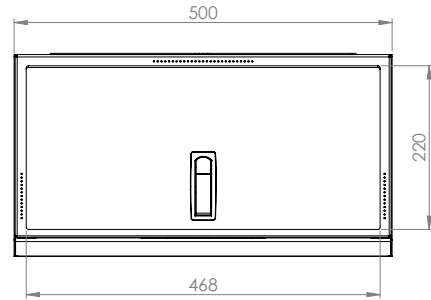

**Compatible car models:**

- |                      |                  |
|----------------------|------------------|
| Mercedes Sprinter    | Nissan NV400     |
| Volkswagen Crafter I | Renault Master 3 |
| Volkswagen LT        | Opel Movano 2    |
| Ford Transit MK8     |                  |

**Note:**

Moon Box Wood versions: total width increases by 20mm compared to standard models. Side panels use identical construction as front panels - plywood with natural oak veneer finish.

# MoonBox IO 65 angle 90°

Maximum self load

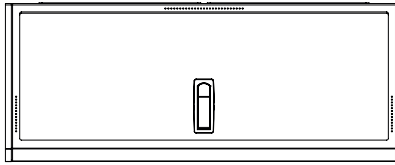

**MOON BOX IO 65**

Maximum self load

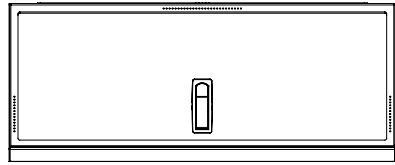

**MOON BOX IO MOLLE 65**

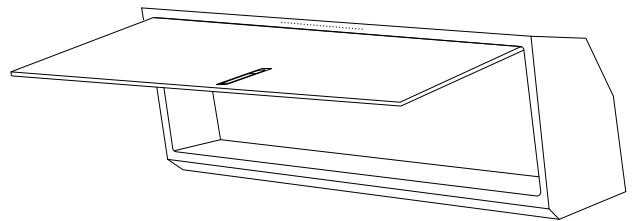
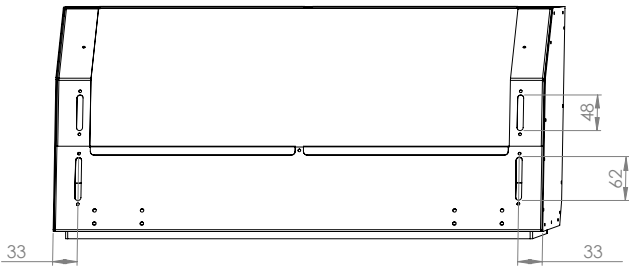
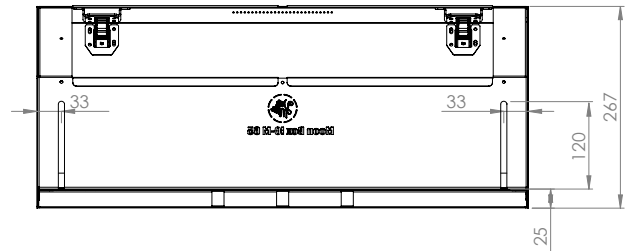
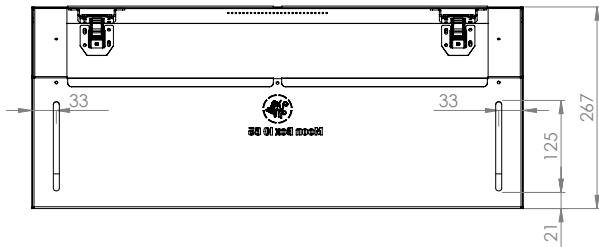
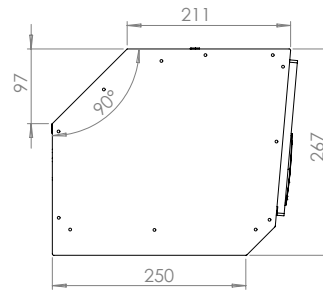
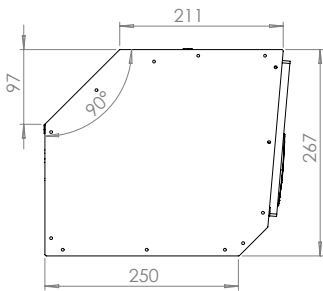
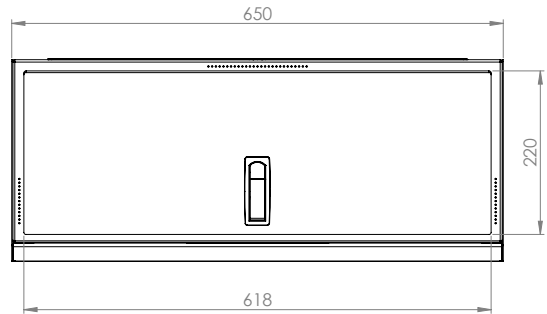
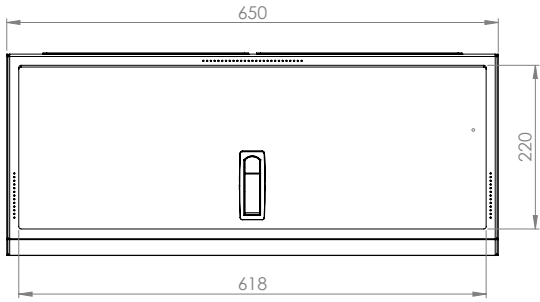

## Compatible car models:

Fits: RVs, Boats & Vans (90° wall-ceiling angle)

## Note:

Moon Box Wood versions: total width increases by 20mm compared to standard models. Side panels use identical construction as front panels - plywood with natural oak veneer finish.

# MoonBox IO 65 angle 101,5°

Maximum self load

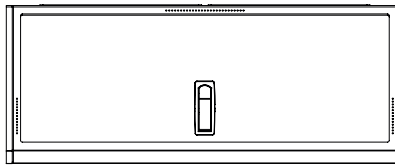

**MOON BOX IO 65**

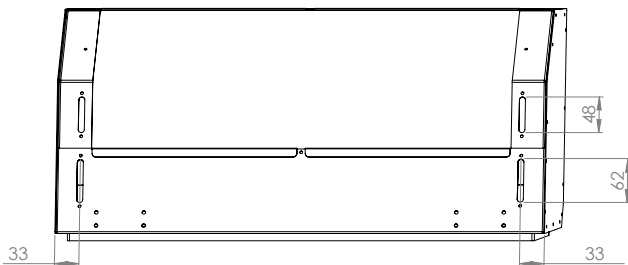
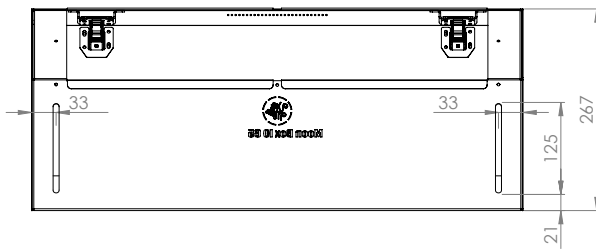
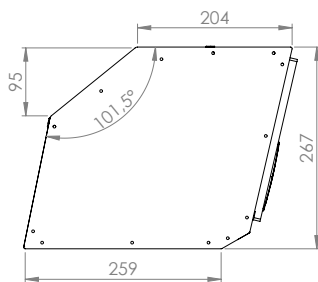
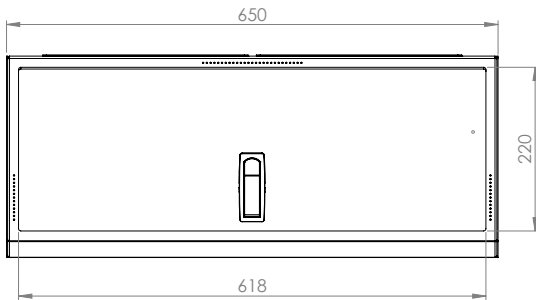

Maximum self load

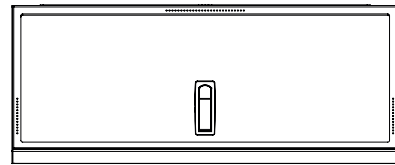

**MOON BOX IO MOLLE 65**

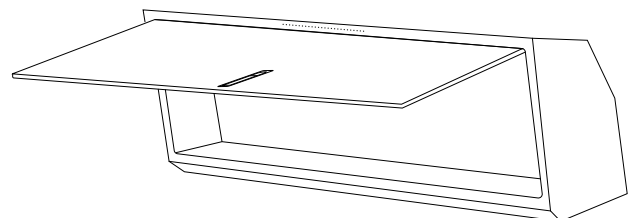
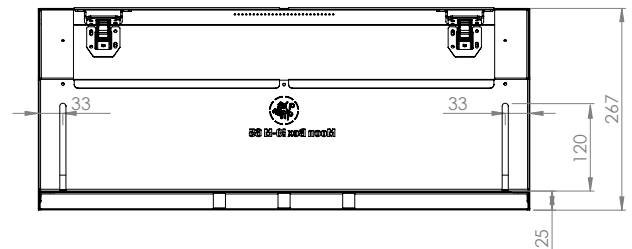
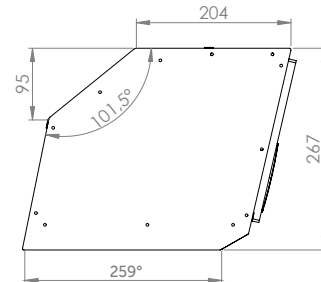
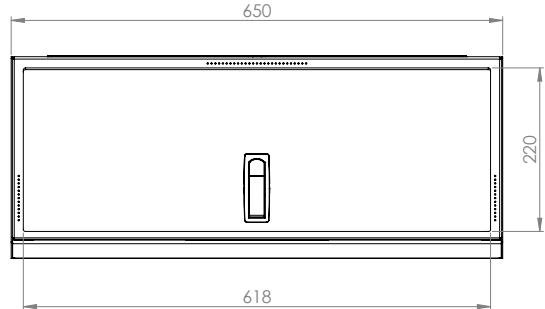

**Compatible car models:**

- |                       |                   |
|-----------------------|-------------------|
| MAN TGE               | Citroen Jumer II  |
| Volkswagen Crafter II | Peugeot Boxer II  |
| RAM Promaster         | Opel Movano 3     |
| Fiat Ducato III       | Toyota Proace Max |

**Note:**

Moon Box Wood versions: total width increases by 20mm compared to standard models. Side panels use identical construction as front panels - plywood with natural oak veneer finish.

# MoonBox IO 65 angle 105°

Maximum self load

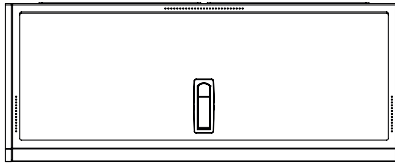

**MOON BOX IO 65**

Maximum self load

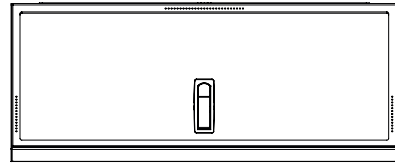

**MOON BOX IO MOLLE 65**

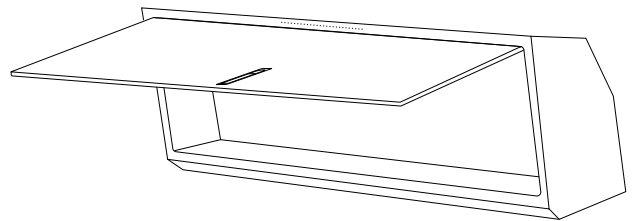
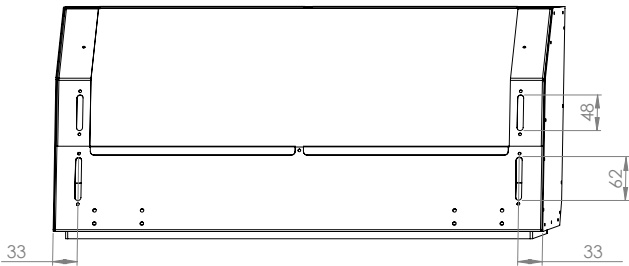
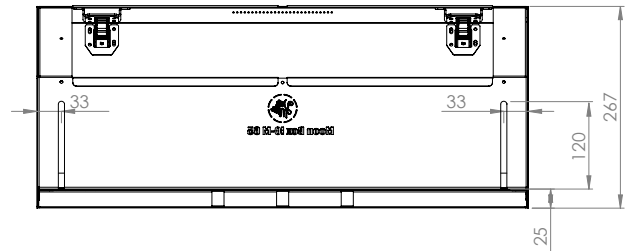
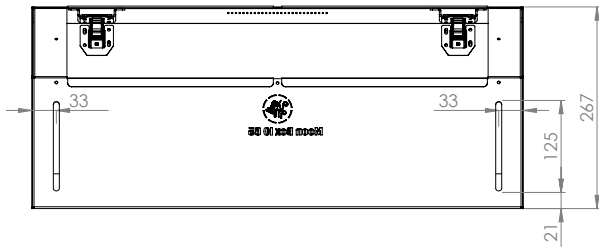
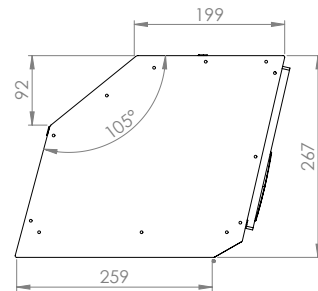
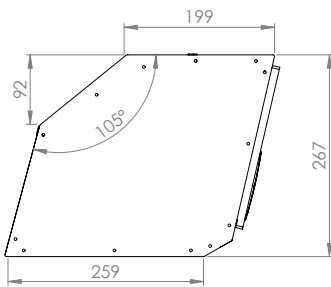
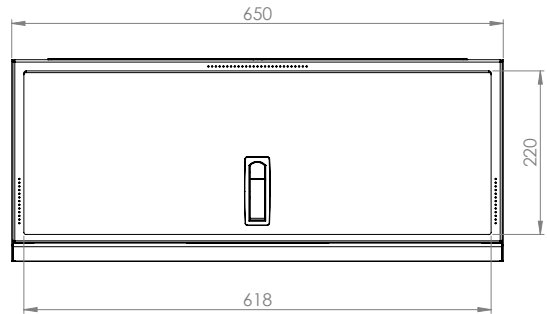
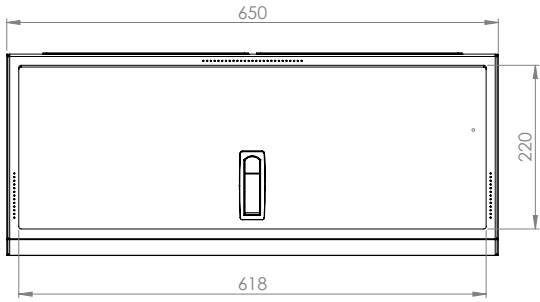

**Compatible car models:**

Ford Transit MK7

**Note:**

Moon Box Wood versions: total width increases by 20mm compared to standard models. Side panels use identical construction as front panels - plywood with natural oak veneer finish.

# MoonBox IO 65 angle 109°

Maximum self load

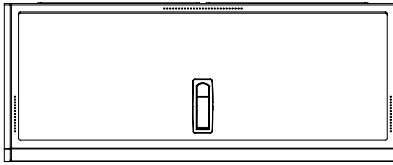

**MOON BOX IO 65**

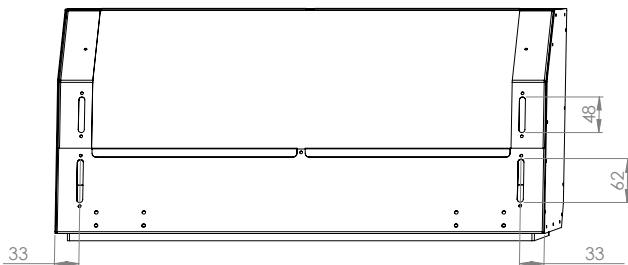
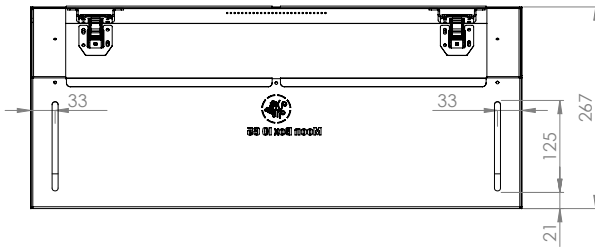
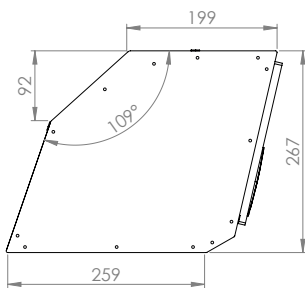
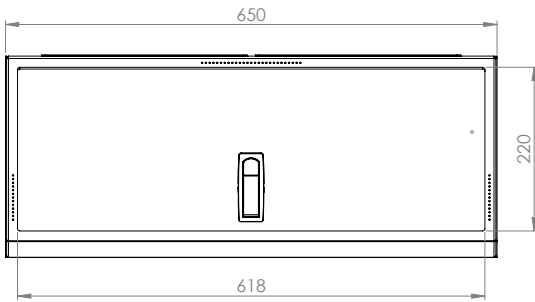

Maximum self load

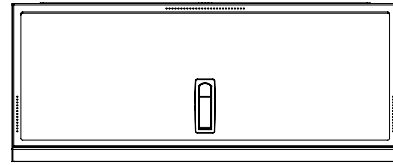

**MOON BOX IO MOLLE 65**

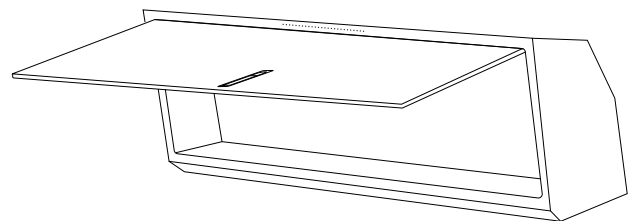
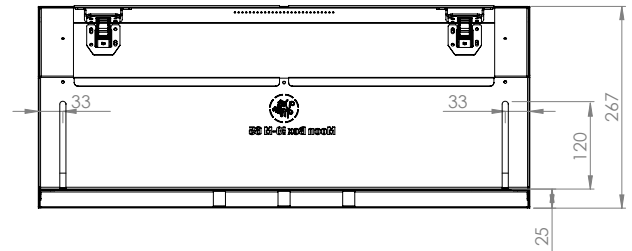
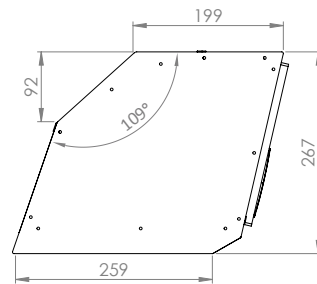
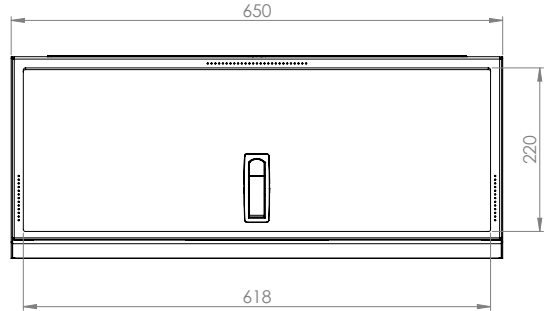

## Compatible car models:

- |                      |                  |
|----------------------|------------------|
| Mercedes Sprinter    | Nissan NV400     |
| Volkswagen Crafter I | Renault Master 3 |
| Volkswagen LT        | Opel Movano 2    |
| Ford Transit MK8     |                  |

## Note:

Moon Box Wood versions: total width increases by 20mm compared to standard models. Side panels use identical construction as front panels - plywood with natural oak veneer finish.



# MoonBox IO Kitchen 65

# angle 109°

Maximum self load

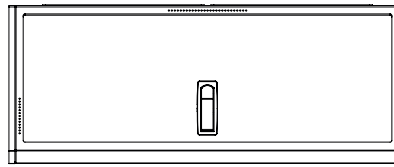

MOON BOX IO KITCHEN 65

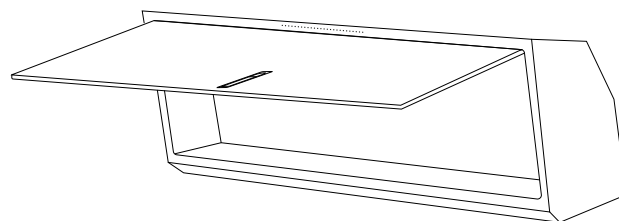
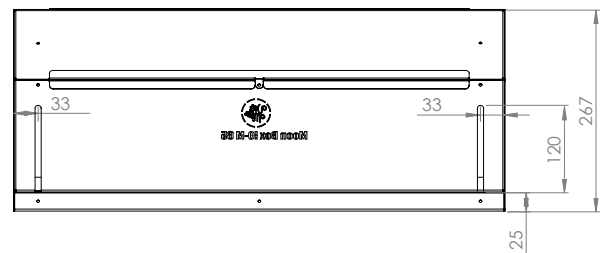
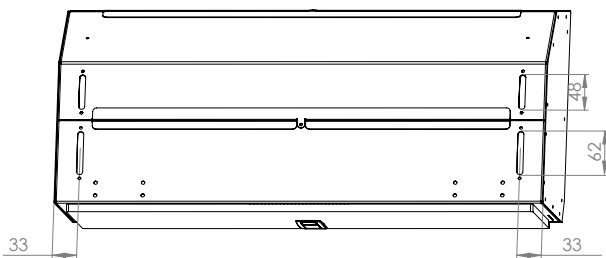
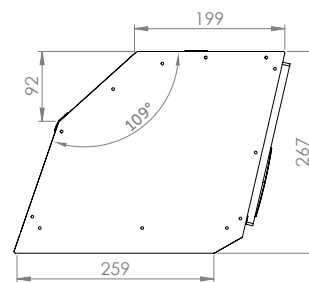
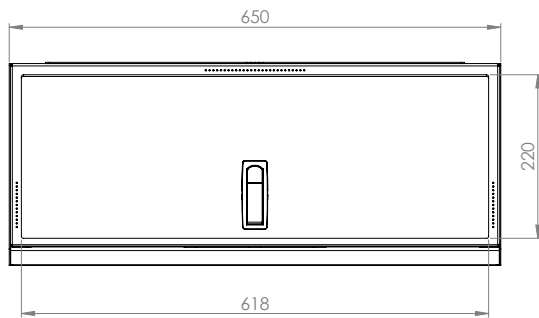

## Compatible car models:

Mercedes Sprinter  
Volkswagen Crafter I  
Volkswagen LT  
Ford Transit MK8

Nissan NV400  
Renault Master 3  
Opel Movano 2

## Note:

Moon Box Wood versions: total width increases by 20mm compared to standard models. Side panels use identical construction as front panels - plywood with natural oak veneer finish.

---

# Information **regarding use**

---



## **Cleaning**

Clean aluminum surfaces with a soft cloth and mild detergent. For oak veneer parts, use specialized wood furniture cleaners. Avoid abrasive materials and harsh chemicals. Keep ventilation points clear of debris. Wipe dry after cleaning to prevent water spots.



## **Composition**

Aircraft-grade aluminum construction, natural oak veneer plywood fronts, professional-grade hardware



## **Transport and storage**

The products are packed in cardboard outer packaging.  
During transport, they should be placed horizontally or vertically.  
Must be transported in the original packaging.



## **Disposal of the packaging**

The packaging is made of recyclable cardboard, so it should not be thrown away, but stored in a landfill in waste paper bins or special containers for cardboard packaging.



## **Precautions**

Please read and understand all installation instructions before mounting the Moon Box IO.

After installation, verify the security of mounting by applying moderate force to test the attachment.

While aluminum construction is UV-resistant, prolonged direct sunlight exposure may affect the natural oak veneer finish.

Keep away from open flames and heat sources.

Follow maximum load capacity guidelines specific to your model.

Use proper tools for installation and package opening to avoid damage.

While the aluminum construction is moisture-resistant, avoid exposing wood elements to excessive moisture.

Periodically check mounting points and hardware for proper tightness.



[www.vandermoon.com](http://www.vandermoon.com)



**Contact**

tel. 48 18 442 33 69  
[shop@vandermoon.com](mailto:shop@vandermoon.com)

Van der Moon® is a registered trademark of the Vitberg Sikora Jacek.  
© Vitberg Sikora Jacek – all rights reserved.  
Made in Poland.

---