

MOONBOX IO

Assemble manual

Hello! Thank you for choosing our products. We put our hearts into making them, so we're even more delighted that you liked them. In the following instructions, you will find all the information you need.

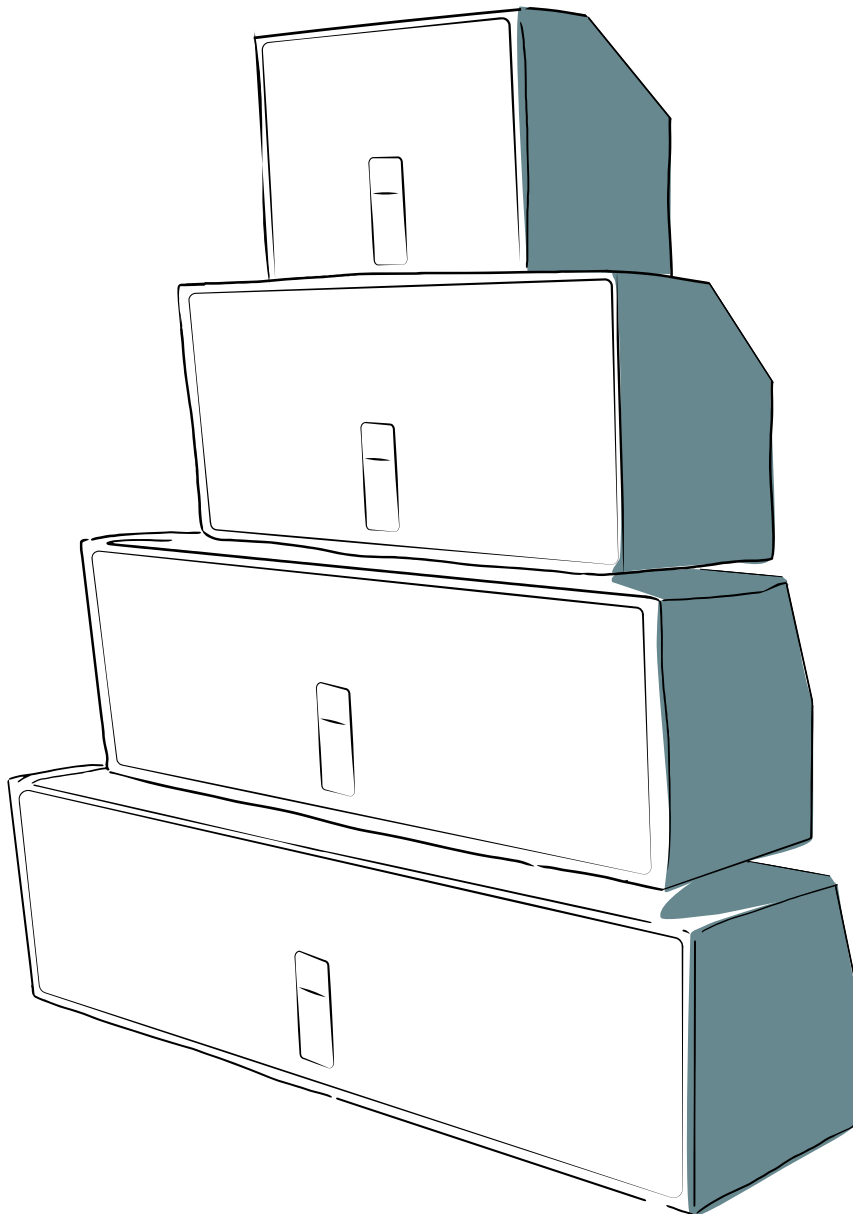

Live light at
vandermoon.com



Models:

Moon Box IO

Moon Box IO ML (Molle+Light)

Moon Box IO W (Wood)

Moon Box IO WML (Wood+Molle+Light)

Moon Box IO K (Kitchen)

Moon Box IO S (Special)



Since 1993, Vitberg has been producing medical devices for rehabilitation, treatment, cosmetology and sports.

Its products are known and appreciated.

Medicine and technology are not our only passion, we also love exploring the world.

We have translated the experience gained over the years into the production of accessories for people like us.

This is how the Van Der Moon brand was born.

Made in Poland, EU.
www.vandermoon.com

Contents

General informations	4
Available versions	5
Maximum shelf load	6
Tools needed	7
Set of elements	7
Prepare your car to assembly Moon Box IO	8
I. Moon Frame	10
II. Moon Frame + Airline	12
III. Airline	15
Information regarding use	17

General **information**

MOON BOX IO – Technical Specification

Moon Box IO represents a new generation of rigid wall-mounted aluminum cabinets specifically designed for campervans and boats. The construction is made entirely of high-quality aluminum, with every element precision-cut and bent in our factory. We assemble all connections using aircraft-grade rivets and additional reinforcement to ensure maximum durability and vibration resistance. The entire structure receives a specialized powder coating through electrostatic spraying, resulting in a perfectly smooth surface with exceptional scratch resistance.

Moon Box IO comes in four sizes (25, 40, 50, or 65 cm) while maintaining a compact height of 26.7 cm for optimal space utilization. The front doors feature lightweight plywood with natural oak veneer, protected by three layers of yacht varnish for lasting durability. Each cabinet comes equipped with professional lever locks that combine durability, reliability, and protection against accidental opening during travel. The hydraulic piston hinges ensure smooth, silent operation while providing easy access to stored items.

The innovative MOLLE system, available as an option, represents our unique approach to storage customization. Instead of traditional webbing straps, we CNC laser-cut it from aluminum, creating a robust platform for attaching various accessories. Customers can choose to enhance their MOLLE system with integrated LED lighting, featuring both white and red modes for versatile illumination options. The cabinet includes three strategically placed ventilation points that allow for complete air exchange within 45 minutes.

All production stages are carried out in our Polish factory, from initial cutting and bending to final polishing and painting, ensuring precise quality control of each element. We stand behind our product with a 10-year warranty, confirming our confidence in Moon Box IO's durability and performance in any environment.

Available colours:



Dark Grey



Green Dawn



Ecru



Dark Nut Brown

Compatible car models:

Angle 109°

Mercedes Sprinter
Volkswagen Crafter I
Volkswagen LT
Ford Transit MK8
Nissan NV400
Renault Master 3
Opel Movano 2

Angle 101,5°

MAN TGE
Volkswagen Crafter II
RAM Promaster
Fiat Ducato III
Citroen Jumer II
Peugeot Boxer II
Opel Movano 3
Toyota Proace Max

Angle 105°

Ford Transit MK7

Angle 90°

Fits: RVs, Boats & Vans
(90° wall-ceiling angle)

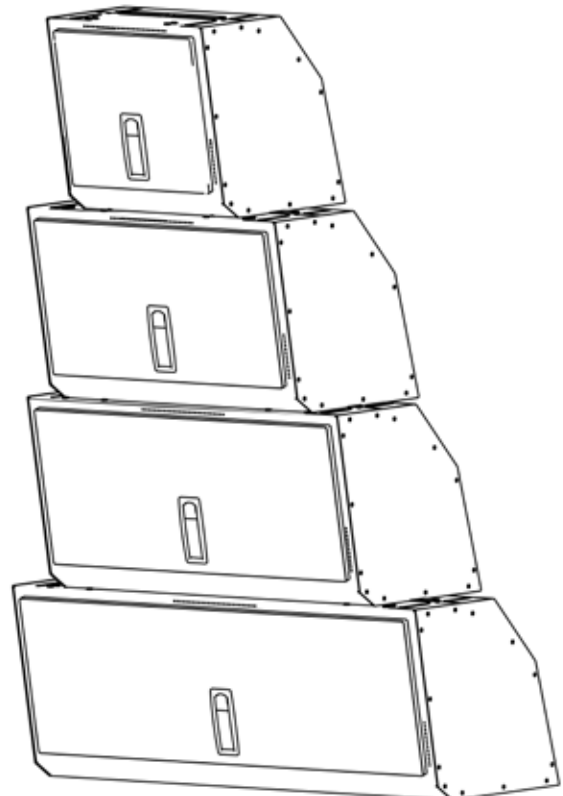

Available **versions**

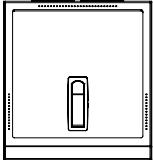

MOONBOX IO 25

Size: 250x267x259 mm
Weight: 1,7 kg (+/-100g)
Capacity: 17 l

MOONBOX IO Wood 25

Size: 268x267x259 mm
Weight: 1,7 kg (+/-100g)
Capacity: 17 l

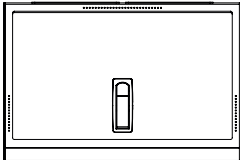

MOONBOX IO 40

Size: 400x267x259 mm
Weight: 2,5 kg (+/-100g)
Capacity: 27 l

MOONBOX IO Wood 40

Size: 418x267x259 mm
Weight: 2,5 kg (+/-100g)
Capacity: 27 l

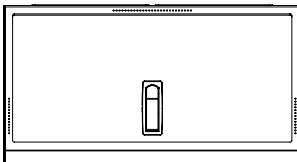

MOONBOX IO 50

Size: 500x267x259 mm
Weight: 3 kg (+/-100g)
Capacity: 34 l

MOONBOX IO Wood 50

Size: 518x267x259 mm
Weight: 3 kg (+/-100g)
Capacity: 34 l

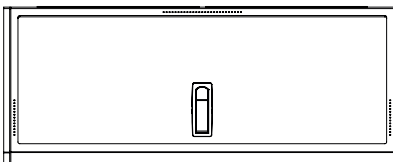

MOONBOX IO 65

Size: 650x267x259 mm
Weight: 3,5 kg (+/-100g)
Capacity: 44 l

MOONBOX IO Wood 65

Size: 668x267x259 mm
Weight: 3,5 kg (+/-100g)
Capacity: 44 l

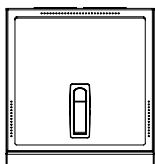

MOONBOX IO Molle 25

Size: 250x267x259 mm
Weight: 2,4 kg (+/-100g)
Capacity: 15 l

MOONBOX IO Wood Molle 25

Size: 268x267x259 mm
Weight: 2,4 kg (+/-100g)
Capacity: 15 l

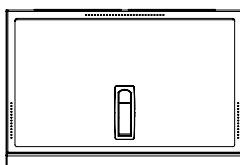

MOONBOX IO Molle 40

Size: 400x267x259 mm
Weight: 3,2 kg (+/-100g)
Capacity: 24 l

MOONBOX IO Wood Molle 40

Size: 418x267x259 mm
Weight: 3,2 kg (+/-100g)
Capacity: 24 l

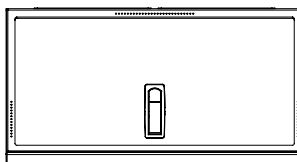

MOONBOX IO Molle 50

Size: 500x267x259 mm
Weight: 3,7 kg (+/-100g)
Capacity: 30 l

MOONBOX IO Wood Molle 50

Size: 518x267x259 mm
Weight: 3,7 kg (+/-100g)
Capacity: 30 l

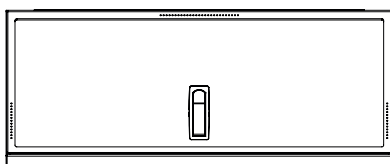

MOONBOX IO Molle 65

Size: 650x267x259 mm
Weight: 4,2 kg (+/-100g)
Capacity: 40 l

MOONBOX IO Wood Molle 65

Size: 668x267x259 mm
Weight: 4,2 kg (+/-100g)
Capacity: 40 l

Maximum **shelf load**

MOON**BOX IO 25**

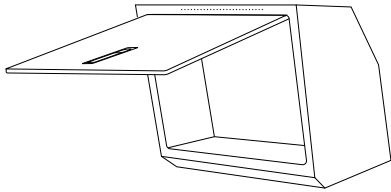

Moon Box IO
without Molle

15
KG

Moon Box IO
with Molle

20
KG

MOON**BOX IO 40**

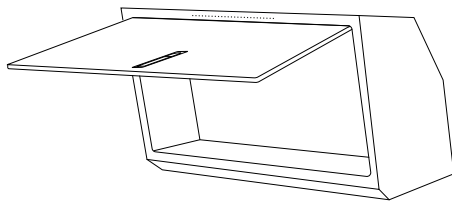

15
KG

20
KG

MOON**BOX IO 50**

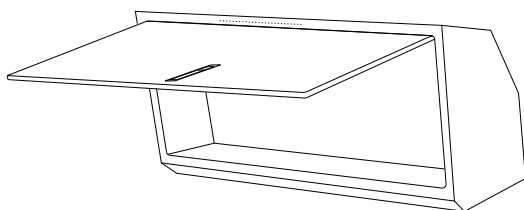

15
KG

20
KG

MOON**BOX IO 65**

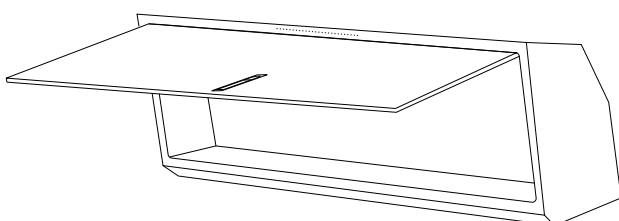

15
KG

20
KG

Tools **needed**



Drill



Riveting machine for blind rivets and/or riveting machines for rivet nuts



Flat-blade screwdriver

Set of **elements**



1A – MOONFIX

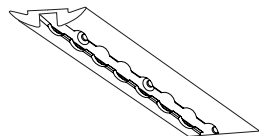

2 – Airline board



4A – Rivet nut M6



5A – Rivet nut M5



1B – MOONFIX

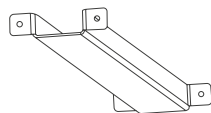

3 – MOONFRAME



4B – Bolt M6



5B – Bolt M5

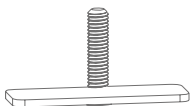

1C – MOONFIX



5C – Screw washer ø 5

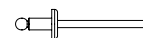

5D – Blind rivet

Prepare your car for assembly MOONBOX IO

MOONBOX IO can be assembled in three ways:

- I. using Moon Frame (3) to which M6 4 rivet nuts are screwed directly (using a sheet metals crewdriver) – **page 10**
- II. using Moon Frame with an additional Arline board – **page 12**
- III. only using Arline boards (without using Moon Frame 3) – **page 15**

IMPORTANT!

To fully load the Moon Box IO (as per the manufacturer's recommendations), you should use the first or second method (Moon Frame mounted to the vehicle's body). Mounting Airline rails will also transfer the full load, BUT ONLY if they are attached to the vehicle's body using rivet nuts or removable rivets (when mounting on sheet metal screws or wood screws, respectively, for sheet metal, plywood, and/or other materials, the manufacturer is not responsible for the load-bearing capacity of these connections).

MOONFRAME assembly

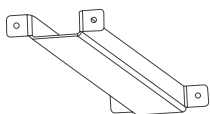

3 – Moon Frame



5A – Rivet nut M5 x4



5B – Bolt M5 x4



5C – Screw washer ø 5 x4



5D – Blind rivet x4

Moon Frame(3) is a structural reinforcement used to mount the Moon Box IO, Airline boards or other suspended accessories.

Moon Frame (3) crossbars to the car body should be fastened on M5 (5A) rivet nuts and M5 bolts (5B) and screw washers (5C) (to protect against unscrewing) or on blind rivets ø 5 (5D).

Moon Frame are not included in the set, you can purchase them separately on our website.



Place the Moon Box IO in the desired location inside the car. Through the upper mounting hole, mark a line on the vehicle's body using a pencil. To the marked line, add the thickness of the upholstery that you will be mounting, and move the marking inwards towards the cabin by that thickness. In the marked location, attach the Moon Frame or AirLine strips in such a way that the marked line is in the center.

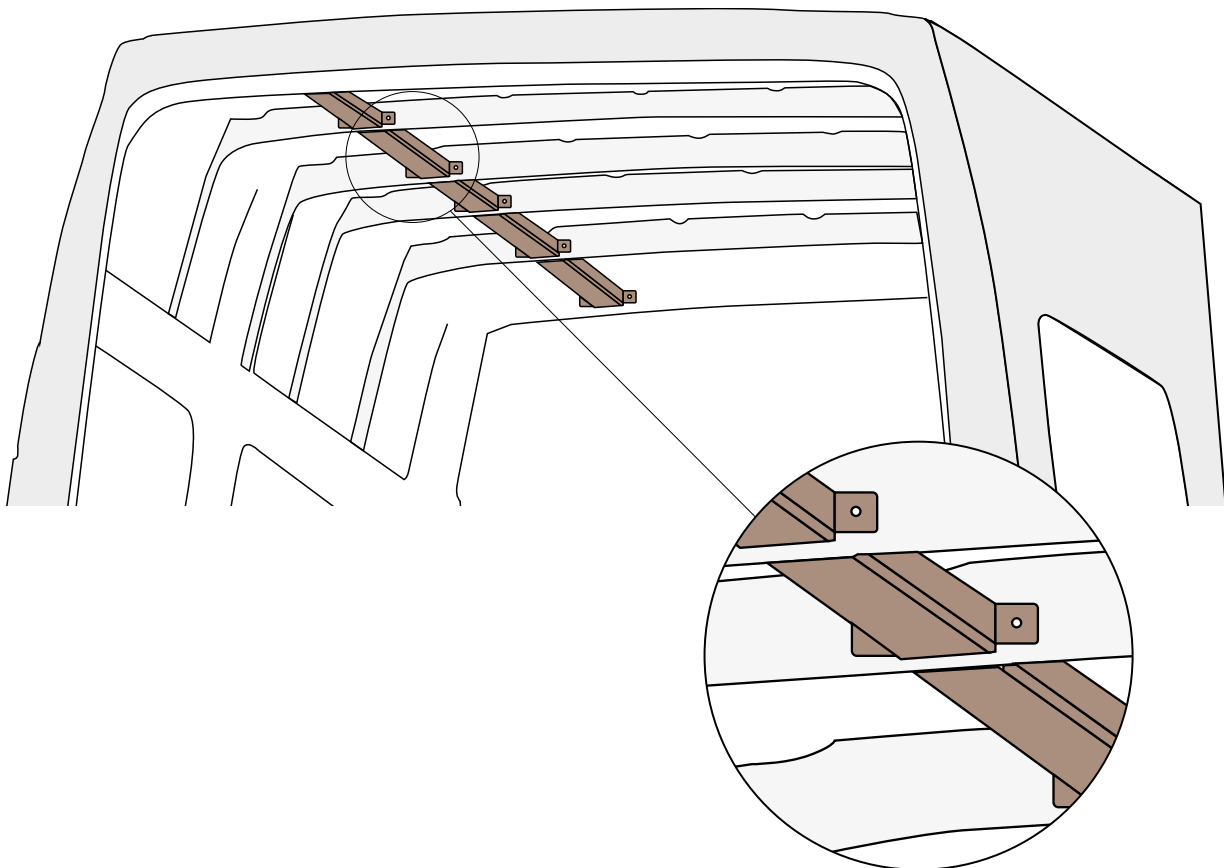
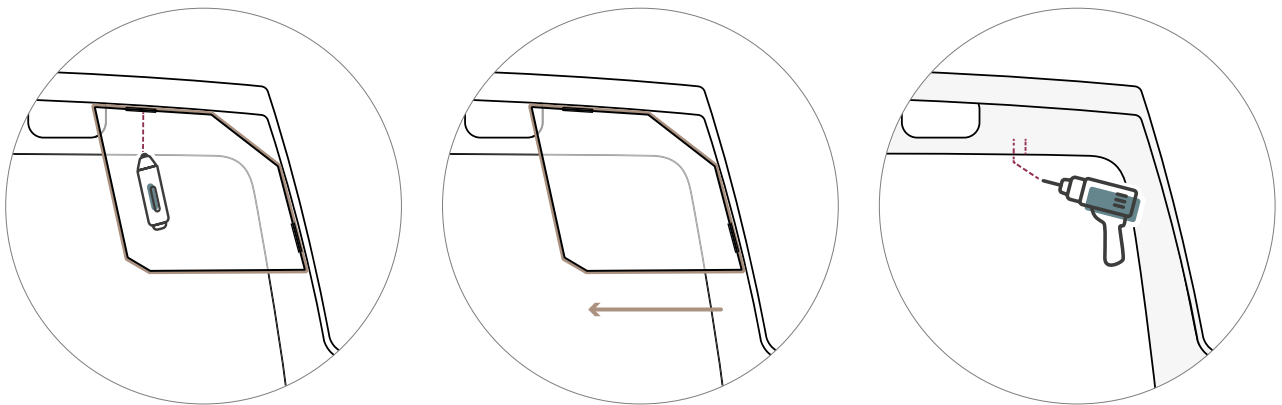

I. MOONFRAME + MOONBOX IO

Step 1

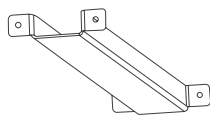

3 – Moon Frame

Mount the Moon Frame (3) reinforcement bars to the vehicle body. Install the ceiling and wall covering (finishing elements not included).

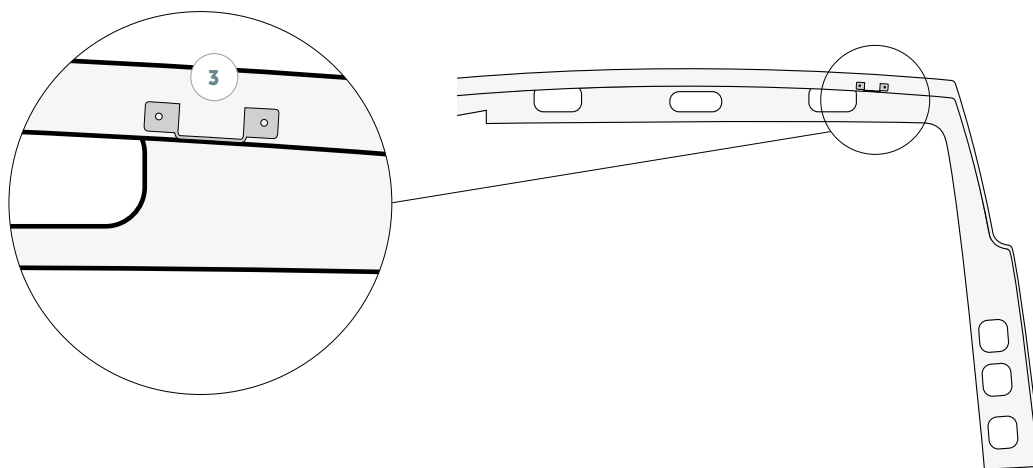

Step 2

Set the Moon Box IO in the target place so that the mounting holes coincide with the previously installed crossbars (3) and mark the places of the holes. The upper mounting holes are to be drilled in the Moon Frame (3) crossbars. The lower mounting holes are to be drilled in the original body reinforcement.

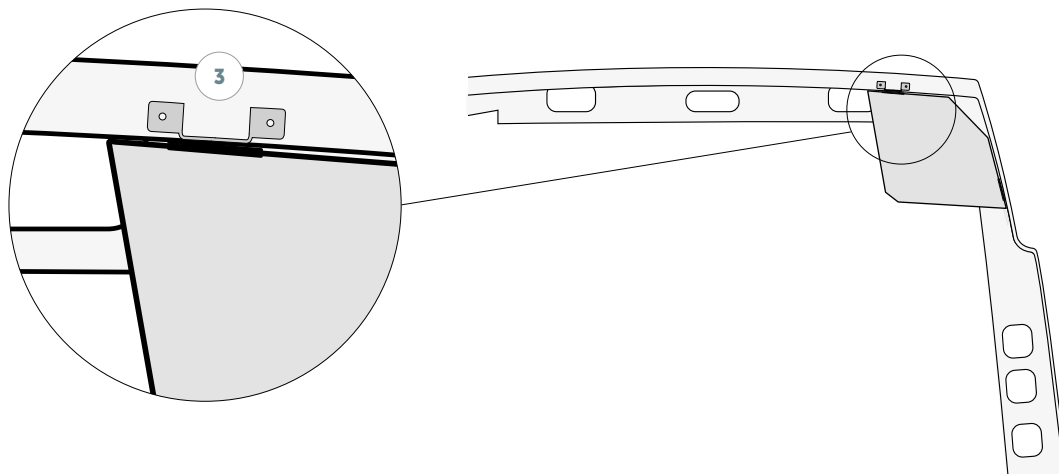

Step 3



4A – Rivet nut M6 x4

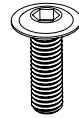

4B – Bolt M6 x4

Rivet the rivet nut into the drilled holes **4A**

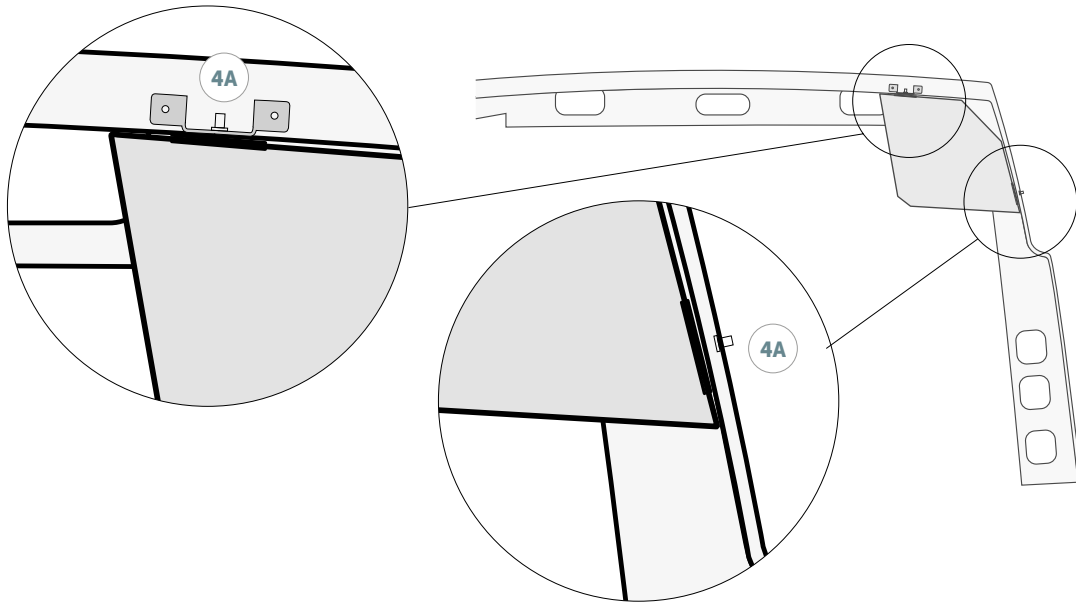

Step 4

Apply the Moon Box IO to the car body in accordance with the drilled holes, screw the element to the structure with M6x40 **4B** screws through the mounting holes in the Moon Box IO

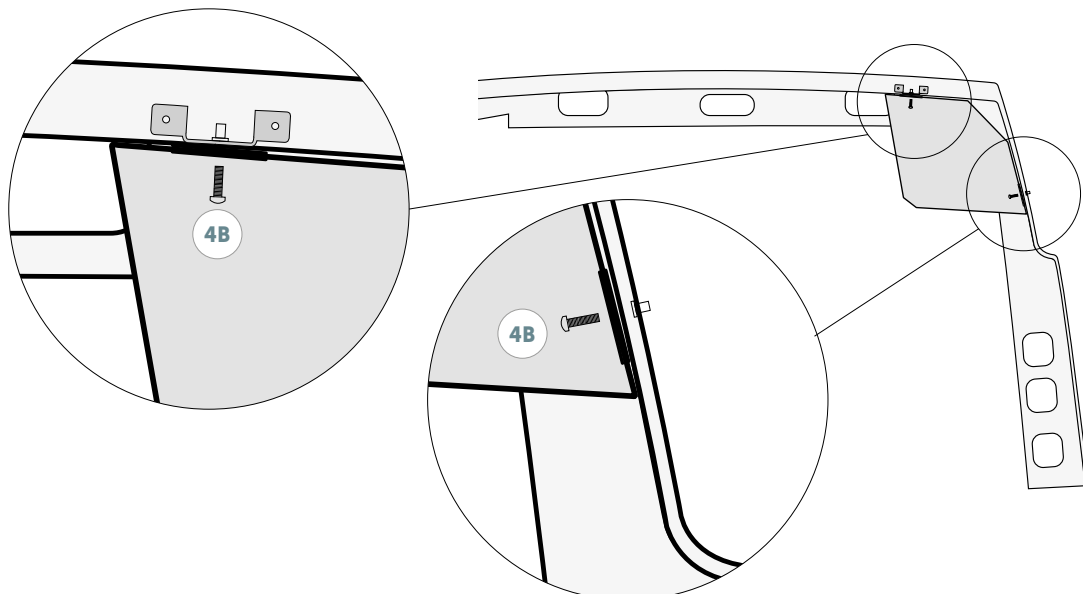

II. MOONFRAME + Airline + MOONBOX IO

Set of mounting elements for Airline board.

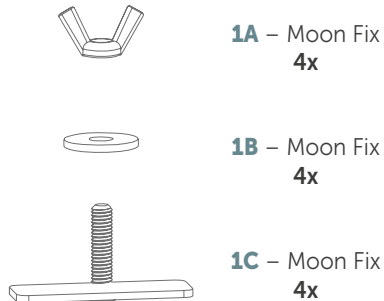

Moon Fix – is a set of mounting screws used in the Moon Box IO installation system.

Moon Fix fits all versions of Moon Box IO.

In set you will find 4 bolts (mounting bolts M6x40, are equipped with a steel element inserted into the Airline board) **1C**, 4 wing nuts M6 **1A** i 4 round washers **1B** (M6/140HVwhite galvanized).

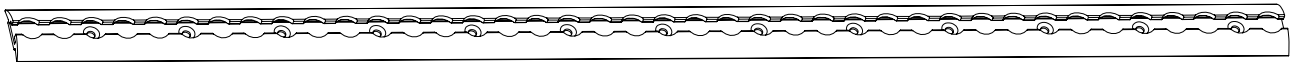

2 – Airline board (It is not included in the set) **2x**

Each Moon Box IO has mounting holes on the back and top. The holes have been prepared for the use of Moon Fix **1** bolts or rivet nuts M6 - **4A** with a bolt M6 - **4B**.

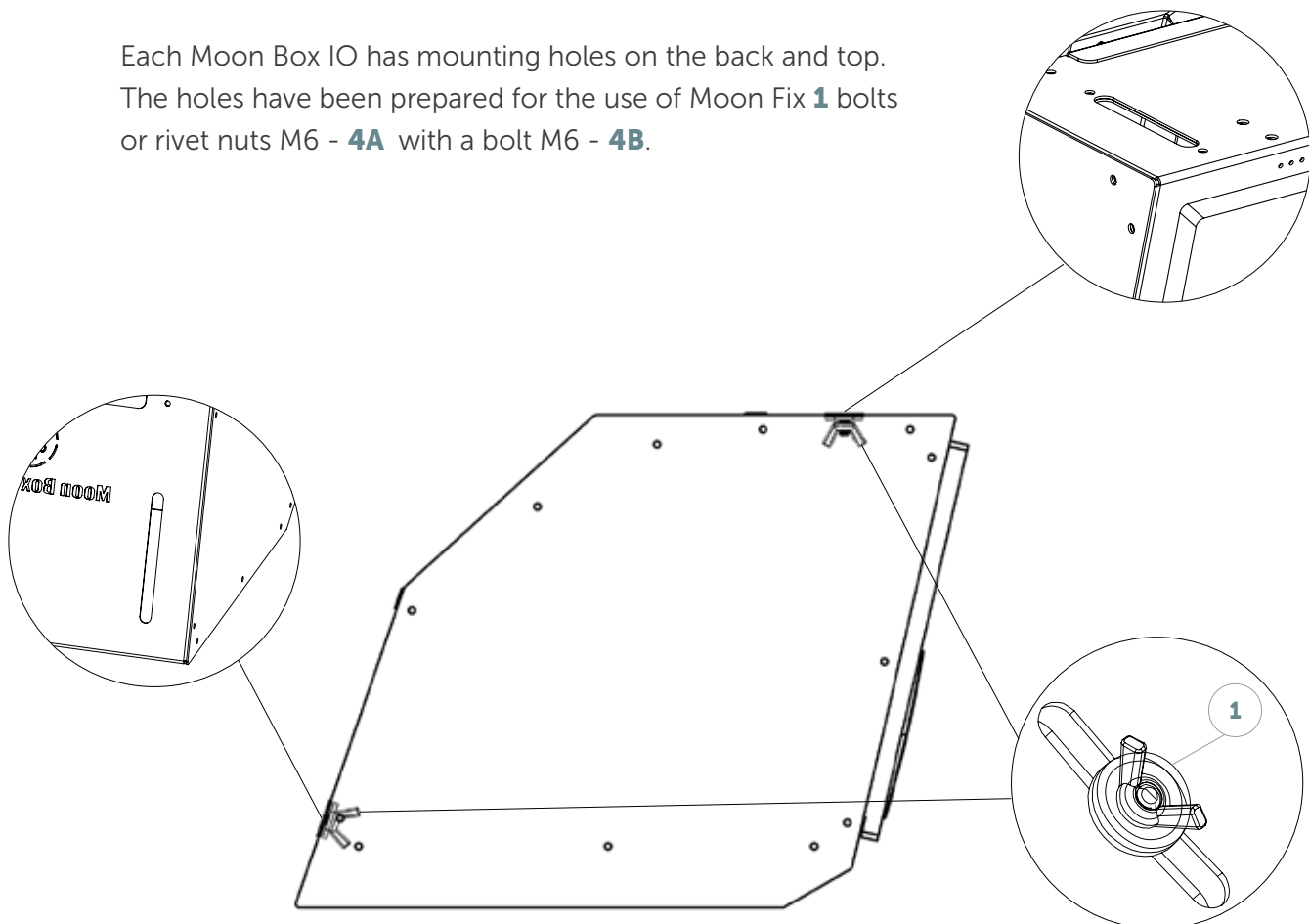

Moon Box IO cross-section - side view.

Step 1

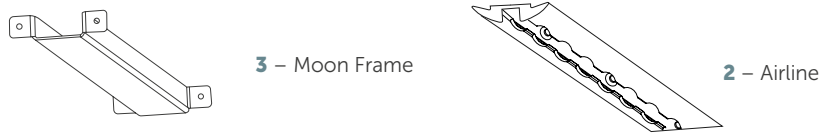

Mount the Moon Frame reinforcement bars (3), to the vehicle's body, to which the Airline board (2) will be attached in subsequent steps. Install the ceiling and wall covering. Finishing elements, reinforcing crossbars and Airline strips are not included in the set.

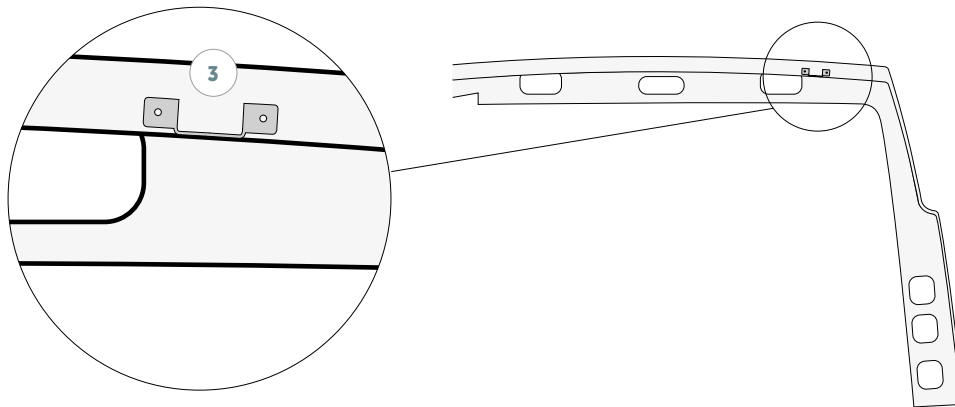

Step 2



Set the Moon Box IO in the target place so that the mounting holes coincide with the previously installed crossbars (3) and mark the places of the holes. The upper mounting holes are to be drilled in the Moon Frame (3) crossbars. The lower mounting holes are to be drilled in the original body reinforcement.

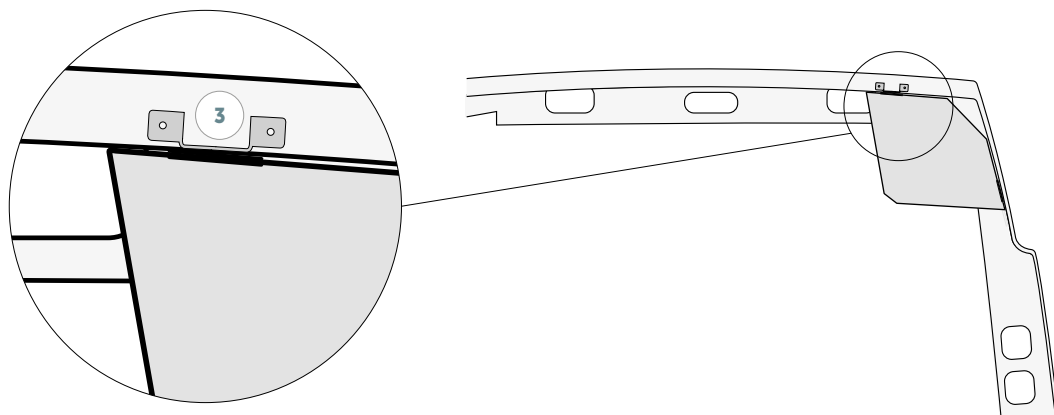

Step 3

Screw the Airline boards to the previously installed reinforcing bars. The connection must be solid and durable. Insert Moon Fix **1C** screws into the mounted Airline board **(2)**. The number of prepared screws must correspond to the number of mounting holes in the planned Moon Box IO installation.

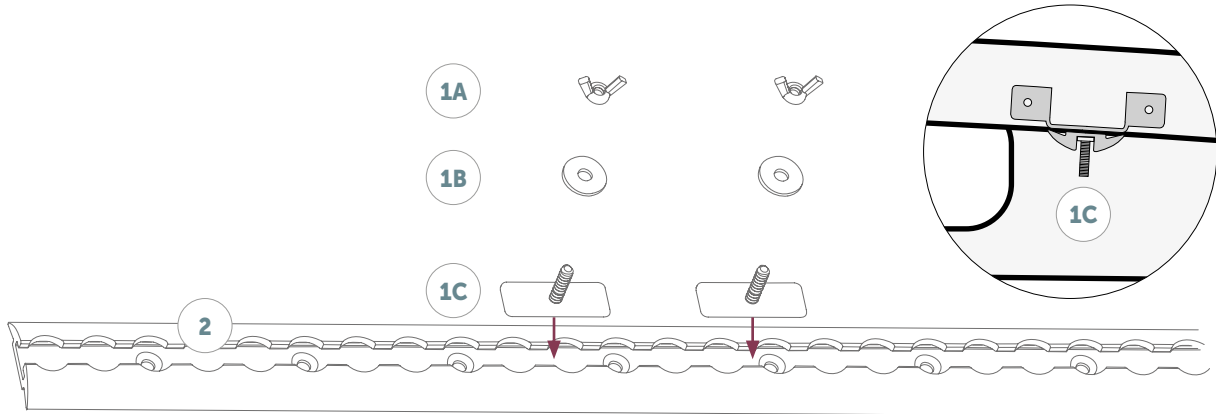

Step 4

Attach the Moon Box IO to the Airline boards **2** by inserting the Moon Fix **1C** bolts through the mounting holes and tightening the wing nuts **1A** and washers **1B** from the inside of the Moon Box IO.

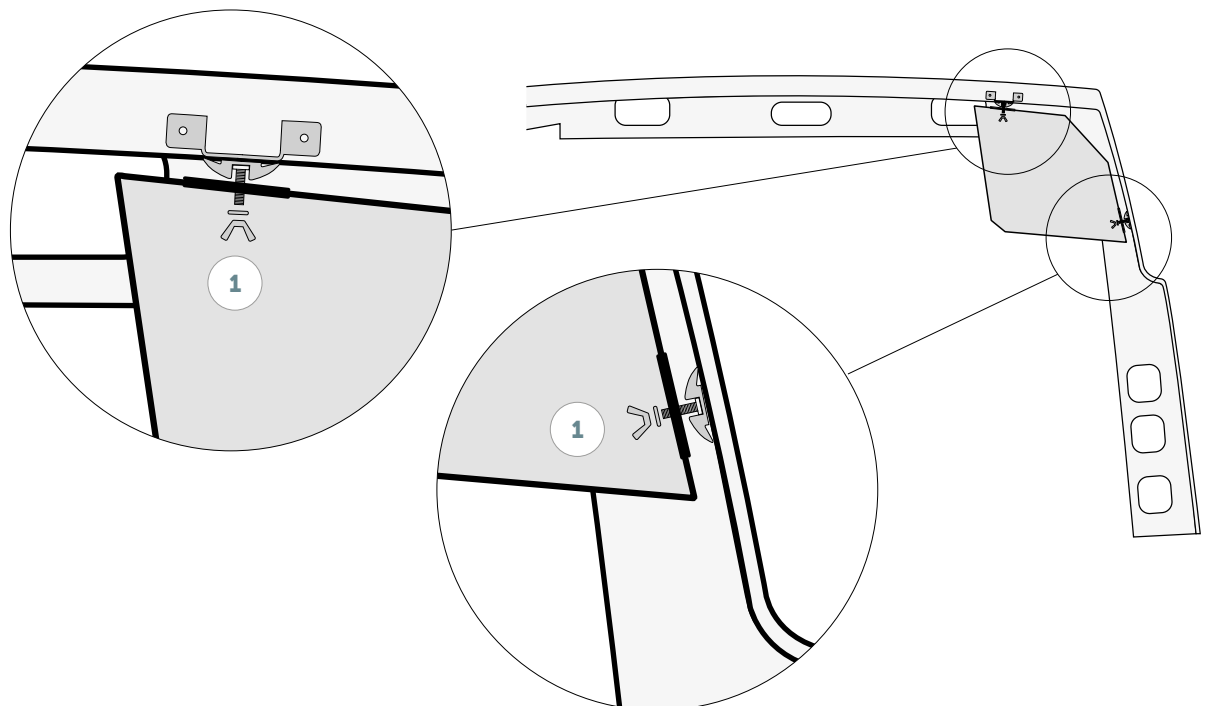

III. Airline + MOONBOX IO

Step 1

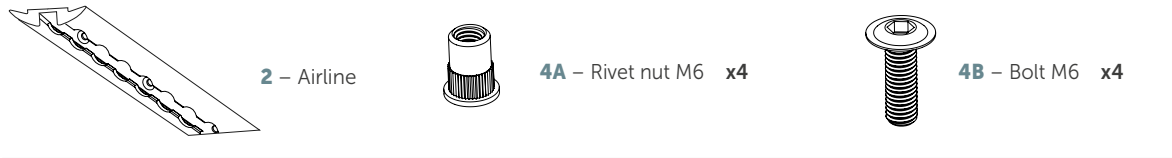

Fasten Airline **2** to the car body with M6 rivet nuts **4A** and M6 countersunk bolts **4B**.

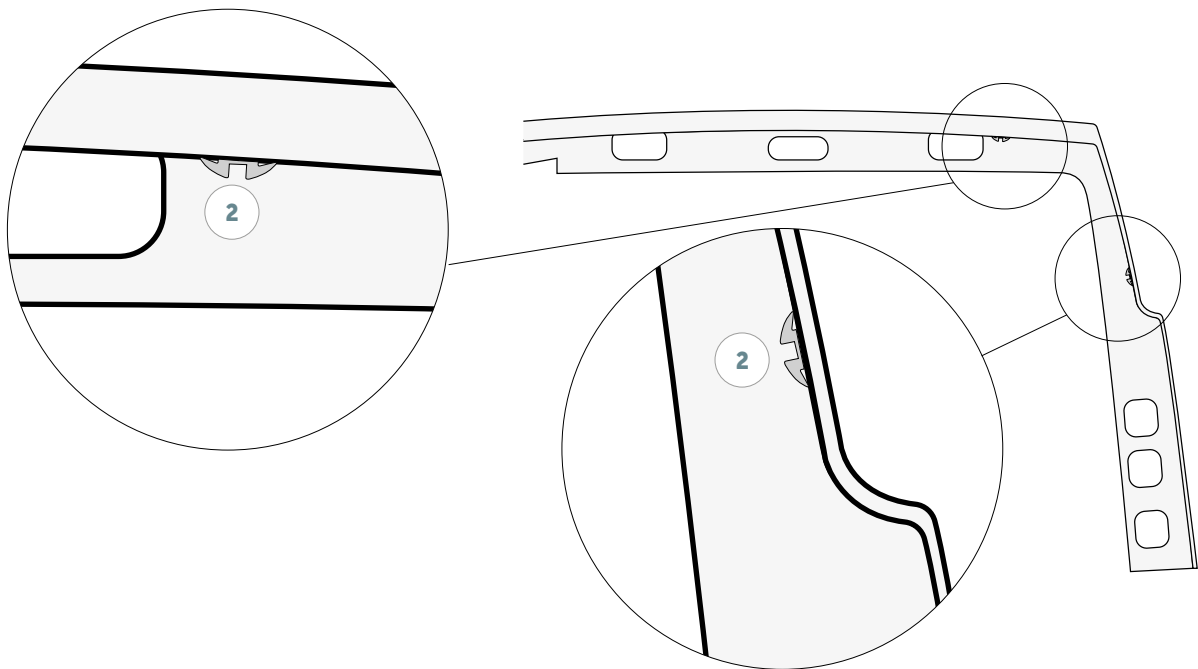

Step 2

Insert the Moon Fix **1C** screws into the installed Airline boards **2**. The number of prepared bolts must correspond to the number of mounting holes in the Moon Box IO planned to be installed.

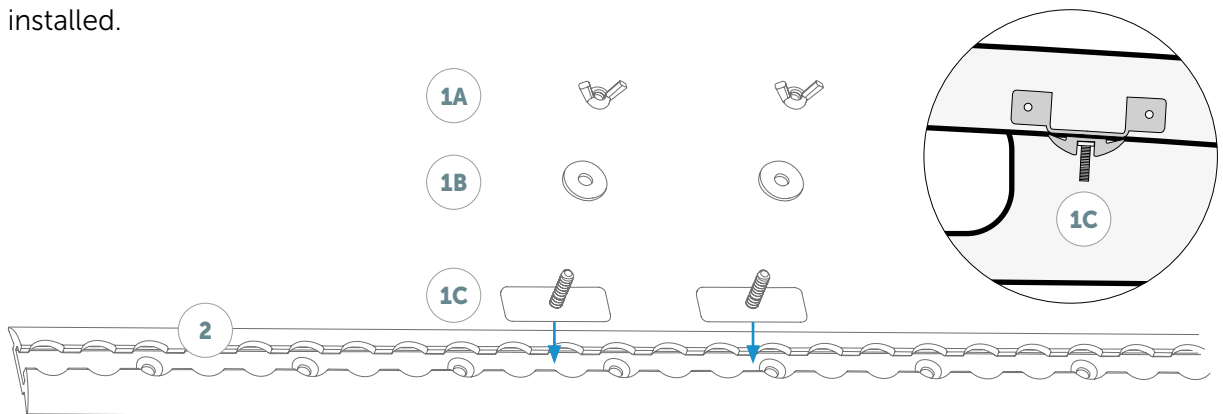

Step 3

Attach the Moon Box IO to the Airline boards **2** by inserting the Moon Fix **1C** bolts through the mounting holes and tightening the wing nuts **1A** and washers **1B** from the inside of the Moon Box IO.

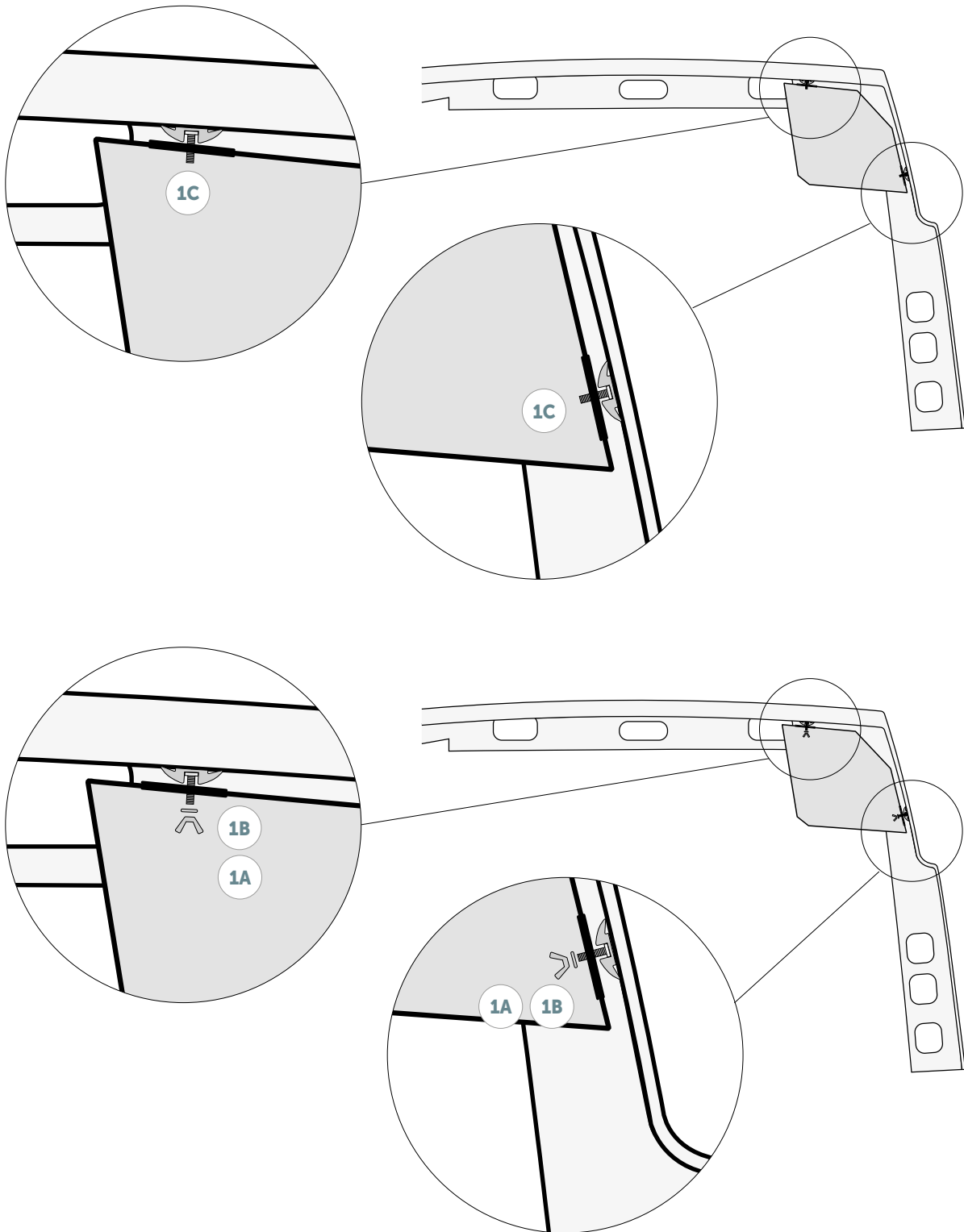

Information **regarding use**



Cleaning

Clean aluminum surfaces with a soft cloth and mild detergent. For oak veneer parts, use specialized wood furniture cleaners. Avoid abrasive materials and harsh chemicals. Keep ventilation points clear of debris. Wipe dry after cleaning to prevent water spots.



Composition

Aircraft-grade aluminum construction, natural oak veneer plywood fronts, professional-grade hardware



Transport and storage

The products are packed in cardboard outer packaging.
During transport, they should be placed horizontally or vertically.
Must be transported in the original packaging.



Disposal of the packaging

The packaging is made of recyclable cardboard, so it should not be thrown away, but stored in a landfill in waste paper bins or special containers for cardboard packaging.



Precautions

Please read and understand all installation instructions before mounting the Moon Box IO.

After installation, verify the security of mounting by applying moderate force to test the attachment.

While aluminum construction is UV-resistant, prolonged direct sunlight exposure may affect the natural oak veneer finish.

Keep away from open flames and heat sources.

Follow maximum load capacity guidelines specific to your model.

Use proper tools for installation and package opening to avoid damage.

While the aluminum construction is moisture-resistant, avoid exposing wood elements to excessive moisture.

Periodically check mounting points and hardware for proper tightness.

The exact specifications, dimensions, capacity, and load-bearing capacity, with distinctions for different versions, are detailed in the Moon Box IO Product Sheet, available for download on the www.vandermoon.com website.





www.vandermoon.com



Contact

tel. +48 18 442 33 69
shop@vandermoon.com

Van der Moon® is a registered trademark of the Vitberg Sikora Jacek.
© Vitberg Sikora Jacek – all rights reserved.
Made in Poland.
